

EN Installation manual / **DE** Montageanleitung / **ES** Manual de montaje /
FR Notice de montage / **IT** Istruzioni di montaggio / **PL** Instrukcja montażu /
RU инструкция по монтажу

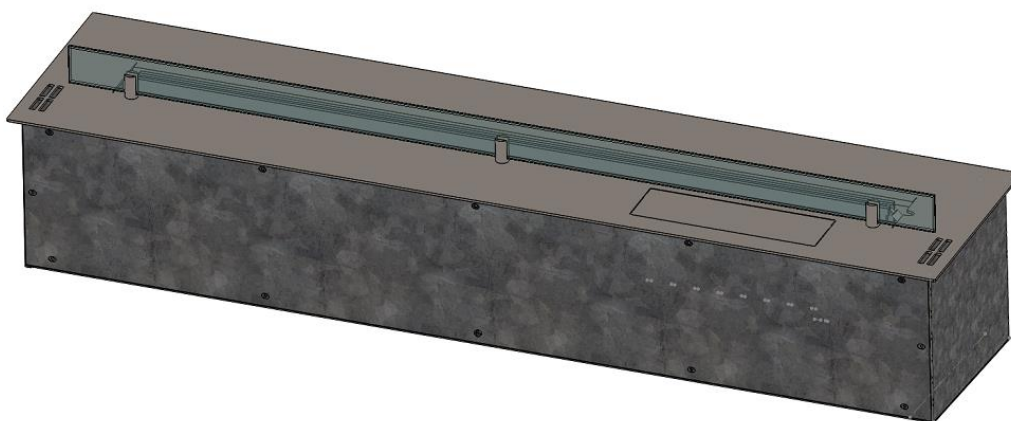

WARNING / WARNUNG / ADVERTENCIA / AVERTISSEMENT / ATTENZIONE / OSTRZEŻENIE / ВНИМАНИЕ

EN This manual only applies to the installation and operation of FLA3 / FLA3+ burner only. The installation of the fireplace in Forma firebox, Daze / Laurent Box is included in the other manual.

DE Diese Anleitung gilt nur für die Installation und den Betrieb des FLA3 / FLA3+ Brenners. Die Installation des Kamins in Forma Feuerraum, Daze / Laurent Box ist in der anderen Anleitung enthalten.

ES Este manual sólo se aplica a la instalación y funcionamiento del quemador FLA3 / FLA3+. La instalación de la chimenea en Forma firebox, Daze / Laurent Box se incluye en el otro manual.

FR Ce manuel s'applique uniquement à l'installation et au fonctionnement du brûleur FLA3 / FLA3+. L'installation de la cheminée dans le foyer Forma, Daze / Laurent Box est incluse dans l'autre manuel.

IT Questo manuale si applica solo all'installazione e al funzionamento del bruciatore FLA3 / FLA3+. L'installazione del caminetto nel focolare Forma, Daze / Laurent Box è inclusa nell'altro manuale.

PL Niniejsza instrukcja dotyczy wyłącznie instalacji i obsługi palnika FLA3 / FLA3+. Instalacja kominka w obudowie Forma, Daze / Laurent Box zawarta jest w innej instrukcji.

RU Данное руководство относится только к установке и эксплуатации только горелки FLA3 / FLA3+. Установка камина в топку Forma, Daze / Laurent Box включена в другое руководство.

EN	INSTALLATION MANUAL	2
DE	MONTAGEANLEITUNG	3
ES	MANUAL DE MONTAJE	3
FR	NOTICE DE MONTAGE	4
IT	ISTRUZIONI DI MONTAGGIO	4
PL	INSTRUKCJA MONTAŻU	5
RU	ИНСТРУКЦИЯ ПО МОНТАЖУ	5
EN	INSTRUCTION MANUAL	14
DE	BEDIENUNGSANLEITUNG	19
ES	MANUAL DE USUARIO	24
FR	NOTICE D'UTILISATION	29
IT	MANUALE D'USO	34
PL	INSTRUKCJA OBSŁUGI	39
RU	ИНСТРУКЦИЯ ПО ЭКСПЛУАТАЦИИ	44



**The product is a decorative device creating real fire.
Read the included documentation prior to installing and operating the device.
Consult the local regulations for fireplaces.**

1. For indoor use and in housing only. Min. temperature of use is 10°C.
2. Natural air exchange rate in room – min. 1/h.
3. Do not use the device in humid and drafty spaces.
4. Do not cover top ventilation openings of the device.
5. No heat-sensitive and flammable objects can be placed within a 1 meter radius from and directly above the device.
6. Do not place any objects on the top of the device.
7. We recommend placing a CO2 or dry powder fire extinguisher nearby the device
8. For service purposes, the surrounding must allow for easy removal of the device.
9. Keep children, animals and unauthorized persons away from the device.
10. Keep the packaging and manuals for future use.
11. Do not turn on the device in case of fuel spill.
12. Do not interfere in the fuel filler when the device is operating.
13. Do not interfere in the device construction.
14. Do not touch the filament and other hot elements.
15. Do not transport the device if fueled.
16. Do not leave an operating device unattended



Es ist ein Dekorationsprodukt und es brennt mit echtem Feuer. Vor der Montage und vor der Inbetriebnahme des Kamins lesen Sie bitte die beigelegte Dokumentation. Machen Sie sich mit den lokalen Vorschriften bezüglich der Kamine vertraut.

1. Der Kamin nur für den Einbau im Innenraum bestimmt. Erforderliche Raumtemperatur min. 10°C.
2. Natürliche Luftwechselrate - min. 1/h.
3. Nicht in Bereichen verwenden, in denen Feuchtigkeit und Zugluft vorkommen können.
4. Die Lüftungsschlitze nicht zudecken.
5. Im Umkreis von einem Meter und direkt über dem Kamin sollten keine brennbare und hitzeempfindliche Gegenstände platziert werden.
6. Keine Gegenstände auf dem Kamin platzieren.
7. Wir empfehlen, einen CO₂- oder Trockenpulver-Feuerlöscher in der Nähe des Geräts aufzustellen
8. Die Montage des Kamins muss eine problemlose Herausnahme zu Wartungszwecken ermöglichen.
9. Den Kamin an einem für Kinder, Unbefugte und Tiere unzugänglichen Ort installieren.
10. Verpackung und Gebrauchsanweisung aufbewahren.
11. Im Falle des Brennstoffauslaufs, das Gerät nicht einschalten
12. Falls der Kamin im Betrieb ist, die Einfüllöffnung nicht berühren
13. In die Konstruktion des Gerätes nicht eingreifen
14. Das Glühelement und andere warmen Elemente nicht berühren
15. Den, mit Brennstoff nachgefüllten Kamin nicht transportieren
16. Das Gerät im Betrieb nicht ohne Aufsicht lassen



El producto es un dispositivo decorativo que produce fuego real. Familiarícese con la documentación adjunta antes de instalar e iniciar el dispositivo. Familiarícese con las regulaciones locales sobre chimeneas.

1. Producto para uso interno y solamente encajado. Usar a una temperatura min. de 10°C
2. Tasa de intercambio de aire natural en la habitación - mín. 1/h.
3. No lo use en lugares con corrientes de aire o humedad.
4. No cubra las ranuras de ventilación.
5. No poner elementos inflamables o sensibles a altas temperaturas dentro de un radio de 1 metro del dispositivo y directamente sobre el dispositivo.
6. Está prohibido colocar objetos en el dispositivo.
7. Se recomienda colocar un extintor de polvo o CO₂ cerca del dispositivo
8. La instalación del dispositivo debe permitir una extracción fácil para el mantenimiento.
9. El dispositivo debe estar protegido contra el acceso de niños, animales y personas no autorizadas.
10. Guarde el embalaje y las instrucciones.
11. No encienda el dispositivo si el combustible se derrama fuera del tanque.
12. No toque el llenador de combustible cuando el dispositivo esté funcionando.
13. No modifique la construcción del dispositivo.
14. No toque el filamento o las partes calientes.
15. No transporte el dispositivo con combustible.
16. No deje el dispositivo funcionando sin supervisión



Le produit est un dispositif décoratif qui produit un feu réel. Familiarisez-vous avec la documentation ci-jointe avant d'installer et de démarrer l'appareil. Familiarisez-vous avec les réglementations locales concernant les cheminées.

1. **Produit à usage interne et uniquement pour l'encastrement. Utiliser à une température min. de 10°C.**
2. **Taux de renouvellement de l'air naturel dans la pièce - min. 1/h.**
3. **Ne pas utiliser dans des endroits humides ou avec des courants d'air.**
4. **Ne couvrez pas les fentes de ventilation.**
5. **Ne pas avoir d'objets inflammables ou sensibles aux températures élevées dans un rayon de 1 mètre de l'appareil ou directement sur l'appareil**
6. **Il est interdit de placer des objets sur l'appareil.**
7. **Il est recommandé de placer un extincteur à poudre ou à CO2 à proximité de l'appareil.**
8. **L'installation de l'appareil doit permettre un retrait facile pour l'entretien.**
9. **L'appareil doit être protégé contre l'accès des enfants, des animaux et des personnes non autorisées.**
10. **Conservez l'emballage et les instructions.**
11. **Ne démarrez pas l'appareil en cas de débordement**
12. **Ne touchez pas le lieu de remplissage de carburant lorsque l'appareil est en marche.**
13. **Ne modifiez pas la construction de l'appareil.**
14. **Ne touchez pas le filament ou les parties chaudes.**
15. **Ne transportez pas l'appareil avec du carburant.**
16. **Ne laissez pas l'appareil fonctionner sans surveillance**



Prodotto è un dispositivo decorativo che produce un vero fuoco. Familiarizzare con il manuale allegato prima di installare e avviare il dispositivo. Familiarizzare con le normative locali relative ai camini.

1. **Dispositivo solo per uso interno e nella struttura ad incasso. Utilizzare a una temperatura min. di 10°C.**
2. **Tasso di ricambio naturale dell'aria nella stanza - min. 1/h.**
3. **Non usare in luoghi umidi e soggetti a correnti d'aria.**
4. **Non coprire le fessure di ventilazione.**
5. **Non posizionare gli oggetti infiammabili o sensibili ad alte temperature entro un raggio di 1 metro e direttamente al di sopra del dispositivo.**
6. **È vietato posizionare oggetti sul dispositivo.**
7. **Si consiglia di posizionare un estintore a polvere o ad anidride carbonica vicino all'unità.**
8. **L'installazione del dispositivo deve consentire una facile rimozione per un eventuale manutenzione.**
9. **Il dispositivo deve essere protetto dall'accesso di bambini, animali e persone non autorizzate.**
10. **Conservare la confezione originale e le istruzioni d'uso.**
11. **Non avviare il dispositivo nel caso di fuoriuscita di carburante dal serbatoio.**
12. **Non operare nei pressi di bocchettone di riempimento quando il dispositivo è in funzione.**
13. **Non interferire nella costruzione del dispositivo.**
14. **Non toccare la resistenza o le parti calde del dispositivo.**
15. **Non trasportare il dispositivo con carburante.**
16. **Non lasciare incustodito il dispositivo.**



Produkt jest urządzeniem dekoracyjnym wytwarzającym prawdziwy ogień. Zapoznaj się z załączoną dokumentacją przed montażem i uruchomieniem urządzenia. Zapoznaj się z lokalnymi przepisami dotyczącymi kominków

1. Urządzenie wyłącznie do użytku wewnętrznego i w zabudowie. Używać w temperaturze min. 10°C.
2. Naturalna wymiana powietrza w pomieszczeniu - min. 1/h.
3. Nie używać w miejscach występowania wilgoci i przeciągów powietrza.
4. Nie zakrywać otworów wentylacyjnych urządzenia.
5. W promieniu 1 metra od oraz bezpośrednio nad urządzeniem nie mogą znajdować się przedmioty łatwopalne i wrażliwe na działanie wysokich temperatur.
6. Zabrania się umieszczania jakichkolwiek przedmiotów na urządzeniu.
7. Zaleca się umieszczenie w pobliżu urządzenia gaśnicy proszkowej lub CO₂.
8. Montaż urządzenia musi umożliwiać bezproblemowe wyjęcie go w celu serwisowania.
9. Urządzenie należy zabezpieczyć przed dostępem dzieci, zwierząt oraz osób niepowołanych.
10. Należy zachować opakowanie oraz instrukcje.
11. Nie uruchamiaj urządzenia w przypadku rozlania paliwa poza zbiornik.
12. Nie operuj przy wlewie paliwa, gdy urządzenie jest uruchomione.
13. Nie ingeruj w konstrukcję urządzenia.
14. Nie dotykaj żarnika oraz rozgrzanych elementów.
15. Nie transportuj urządzenia z paliwem.
16. Nie pozostawiaj uruchomionego urządzenia bez nadzoru.



Продукт является декоративным изделием, производящим настоящий огонь. Ознакомьтесь с приложенной документацией перед монтажом и запуском устройства. Ознакомьтесь с местными правилами, касающимися каминов

1. Устройство предназначено только для использования внутри помещений и после установки. Используйте в температуре 10°C.
2. Естественный воздухообмен в помещении - мин. 1/ч.
3. Не разрешается устанавливать устройство в непосредственной близости к источникам влаги, а также в помещениях со сквозняком.
4. Не закрывать вентиляционных щелей на устройстве.
5. Любые легковоспламеняющиеся и чувствительные на влияние высокой температуры предметы должны находиться за пределами изделия в радиусе мин. 1 м. Одновременно их нельзя устанавливать непосредственно над камином.
6. Запрещается размещать на устройстве любые предметы.
7. Рядом с устройством рекомендуется размещать порошковый или углекислотный огнетушитель.
8. Устройство должно быть установлено таким образом, чтобы его легко можно было извлечь для сервиса.
9. Устройство должно быть защищено от детей, животных и посторонних лиц.
10. Необходимо сохранить оригинальную упаковку устройства, а также настоящую инструкцию.
11. Не включать устройства в случае утечки топлива из бака.
12. Не заправлять камин топливом, когда устройство работает.
13. Не вмешиваться в конструкцию устройства.
14. Не трогать нити накаливания и горячих элементов.
15. Нельзя перемещать устройство, наполненное топливом.
16. Не оставлять запущенного устройства без присмотра

Burner	L [mm]	D [mm]	H [mm]		Minimum Room Size [m ³]
	FLA 3 / FLA 3+	FLA 3 / FLA 3+	FLA3	FLA3+	FLA 3 / FLA 3+
790	790	280	220	305	44
990	990				70
1190	1190				94
1490	1490				130
1990	1990				180
2490	2490				225

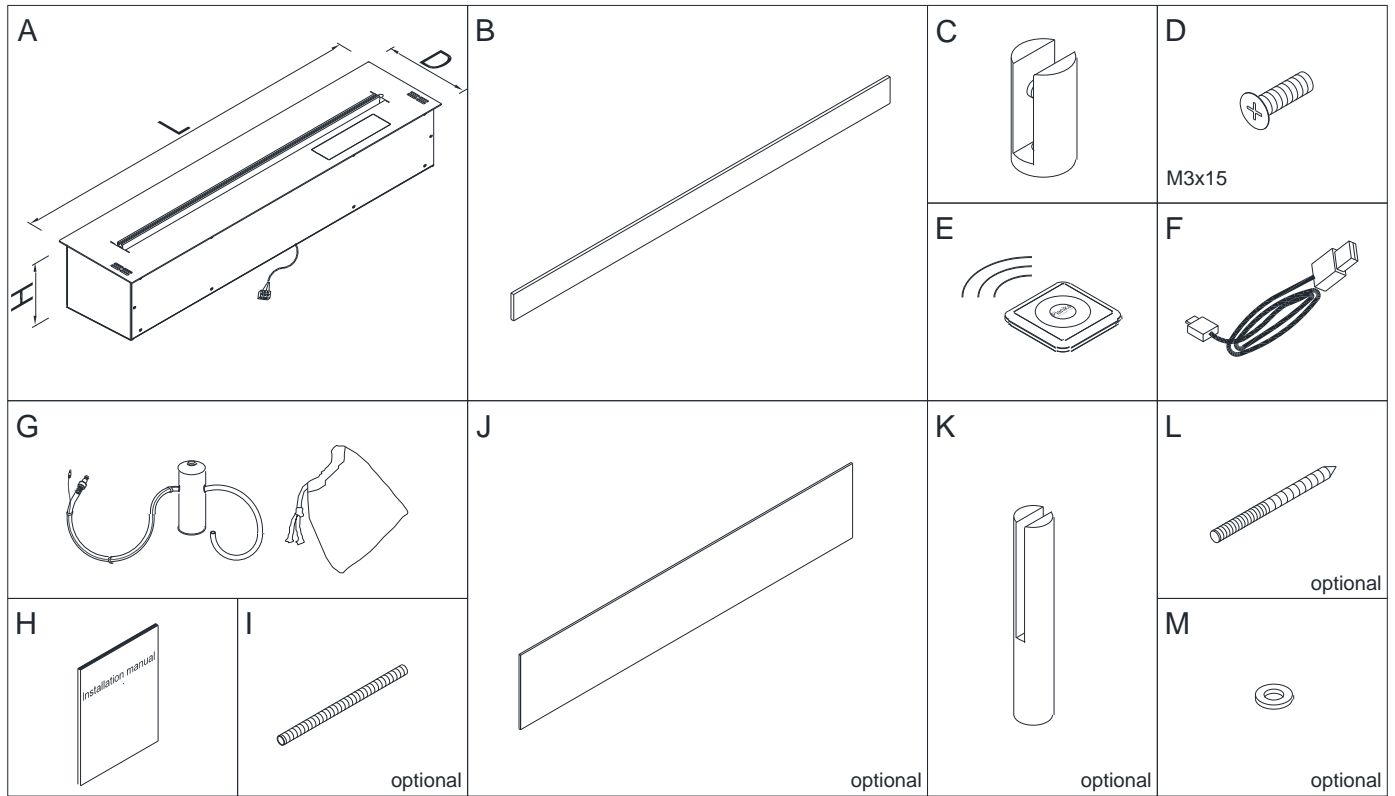

	EN	DE	ES	FR	IT	PL	RU	Quantity
A.	Burner	Brenner	Quemador	Brûleur	Bruciatore	Palnik	Горелка	1
B.	Glass shield	Glasschild	Escudo de cristal	Bouclier de verre	Schermo di vetro	Szyba techniczna	Стеклоанный экран	1x 790, 1x 990, 1x 1190 2x 1490, 2x 1990, 2x 2490
C.	Small glass holder	Glashalterung (klein)	Soporte pequeño	Support petit	Piccolo supporto vetri	Mały kamerton	держатели стекла	2x 790 3x 990, 1190
D.	Glass holder connector	Schraube für Glashalterung	Tornillo para soporte	Vis de support	Le viti per il supporto vetri	Śruba do kamertona	винт для технического стекла	4x 1490, 1990, 6x 2490
E.	Remote control	Fernbedienung	Control remoto	Télécommande	Telecomando	Pilot	пульт дистанционного управления	1
F.	Service cable	Service -Kabel	Cable USB de servicio	Câble de service	Cavetto per l'assistenza tecnica	Kabel serwisowy	кабель сервиса	1
G.	Fuel pump	Brennstoffpumpe	Bomba de combustible	Pompe	Pompa di rifornimento	Pompka paliwa	топливный насос	1
H.	Installation and user's manual	Montageanleitung Bedienungsanleitung	Manual de montaje, de usuario	Notice de montage et d'utilisation	Istruzioni d'uso e montaggio	Instrukcja montażu i obsługi	инструкция по монтажу и эксплуатации	1
I.	Windscreen connector type 1	Windschutzscheibenanschluss Typ 1	Conector parabrisas tipo 1	Connecteur de pare-brise type 1	Connettore parabrezza tipo 1	Łącznik panelu szklanego typ 1	Разъем ветрового стекла тип 1	4x 790, 990, 1190, 1490, 8x 1990, 2490
J.	Windscreen	Glaspanel	Panel de vidrio	Panneau en verre	Pannelo di vetro	Panel szklany	стеклянная палень	2x 790, 990, 1190, 1490, 4x 1990, 2490
K.	Tall glass holder	Großer Glashalter	Portavasos alto	Grand porte-verre	Portabicchieri alto	Wysoki uchwyt do paneli szklanych	Высокий держатель для стаканов	4x 790, 990, 1190, 1490, 8x 1990, 2490
L.	Windscreen connector type 2	Windschutzscheibenanschluss Typ 2	Conector parabrisas tipo 2	Connecteur de pare-brise type 2	Connettore parabrezza tipo 2	Łącznik panelu szklanego typ 2	Разъем ветрового стекла тип 2	4x 790, 990, 1190, 1490, 8x 1990, 2490
M.	Washer	Unterlegscheibe	Arandela del perno	Rondelle de boulon	Rondella per bulloni	Podkładka	Стиральная машина	

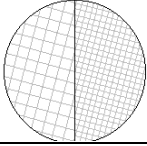

EN NON-FLAMMABLE MATERIAL
DE NICHT BRENNBARE MATERIALIEN
FR MATÉRIAU NON INFLAMMABLE

ES MATERIAL NO INFLAMABLE
IT MATERIALE NON INFIAMMABILE
PL MATERIAŁ NIEPALNY
RU НЕВОСПЛАМЕНЯЮЩИЙСЯ МАТЕРИАЛ

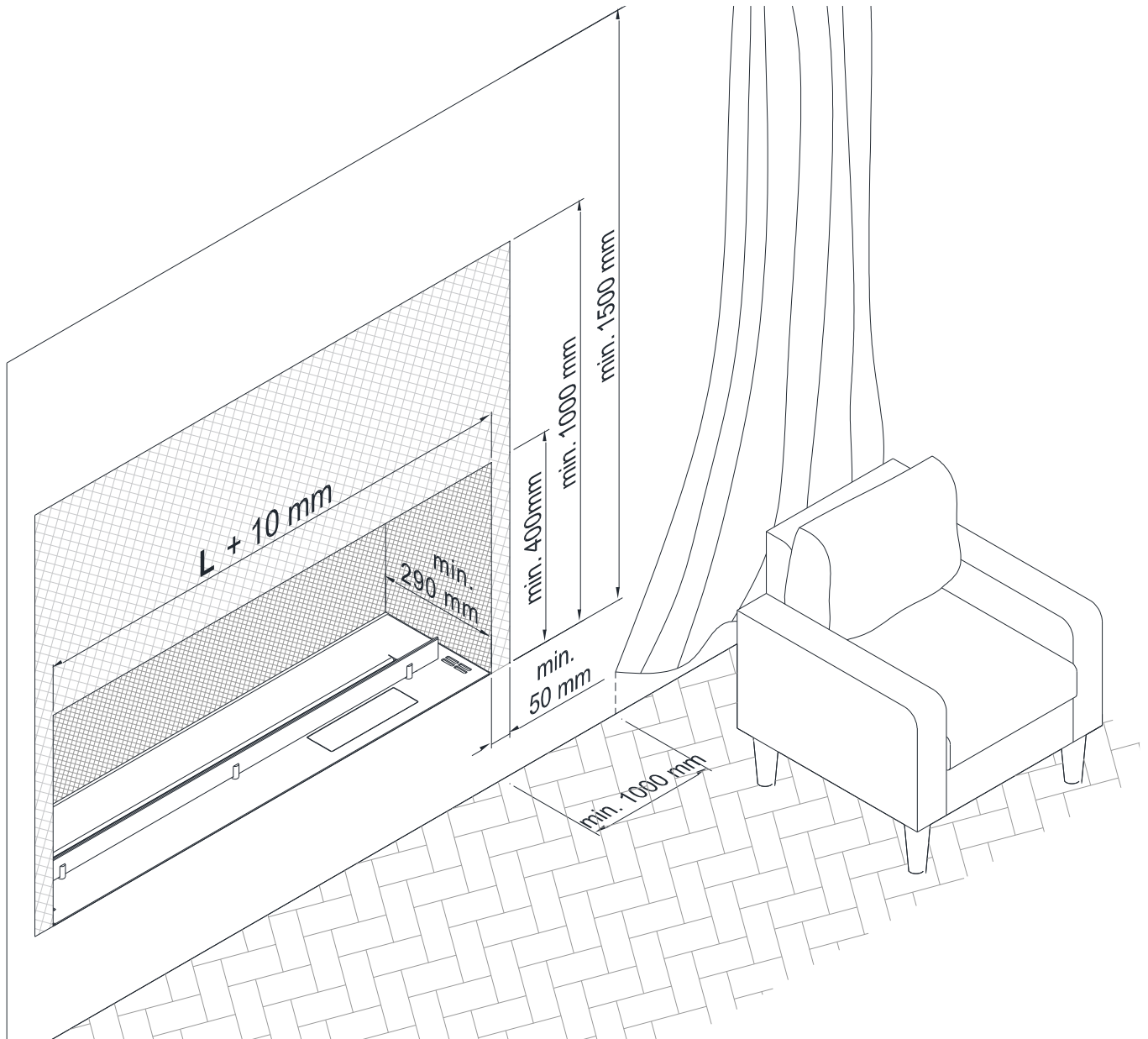

EN	The fireplace surrounding must be made of non-flammable materials and insulated from any flammable elements of the construction. Use only fasteners and adhesives that are resistant to high temperature.
DE	Das Gehäuse aus nicht brennbaren Materialien angefertigt, von allen brennbaren Elementen der Konstruktion isoliert.
ES	El encajamiento debe ser de materiales no combustibles, aislado de todos los elementos inflamables de la estructura. Los conexiones y aglutinantes deben ser resistentes a altas temperaturas.
FR	L'encastrement doit être de matériaux incombustibles, isolé de tous les éléments inflammables de la construction. Les raccordement et liants doivent être résistants aux hautes températures.
IT	La struttura ad incasso deve essere fatta di materiali non combustibili, isolati da tutti gli elementi infiammabili della struttura. Collegamenti e leganti devo essere resistenti alle alte temperature.
PL	Zabudowa wykonana z materiałów niepalnych, odizolowana od wszelkich palnych elementów konstrukcji. Łączenia i spoiwa odporne na działanie wysokich temperatur.
RU	Конструкция, в которой установлен камин должна быть изготовлена из невоспламеняющихся материалов, и она должна быть изолированной от любых воспламеняющихся элементов. В качестве соединений, адгезивных веществ используйте термостойкие продукты.

1.

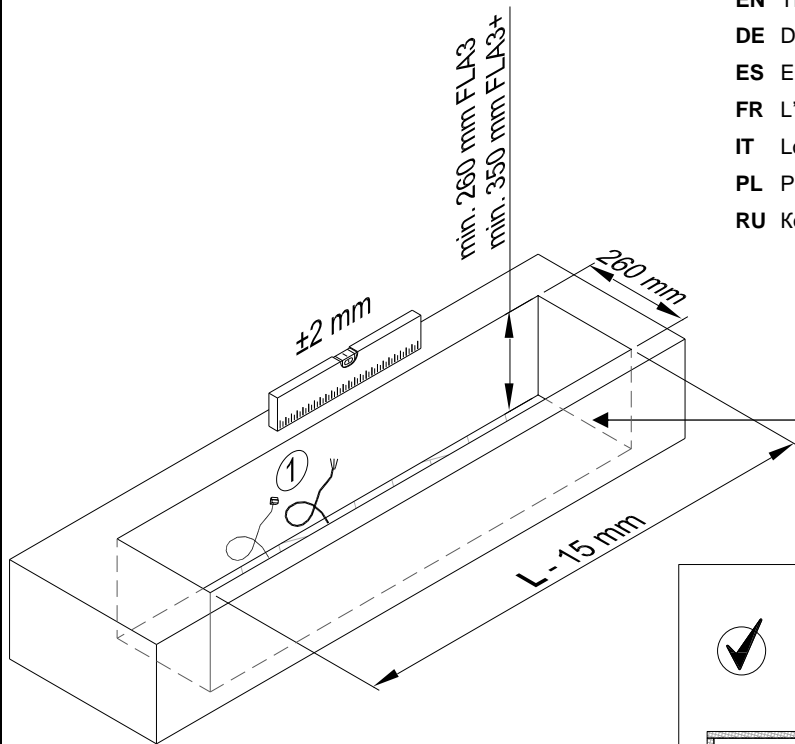

① Min. 3x1,5 mm², 230 V, 50 Hz,
PE 
Optional SHS connection

- EN The space under the device must be closed.
- DE Die Konstruktion unter dem Kamin muss geschlossen sein.
- ES El espacio debajo del dispositivo debe ser cerrado.
- FR L'espace sous le dispositif doit être fermé.
- IT Lo spazio al di sotto del camino deve essere chiuso.
- PL Przestrzeń pod urządzeniem musi być zamknięta.
- RU Конструкция под тело устройства должна быть закрытой.

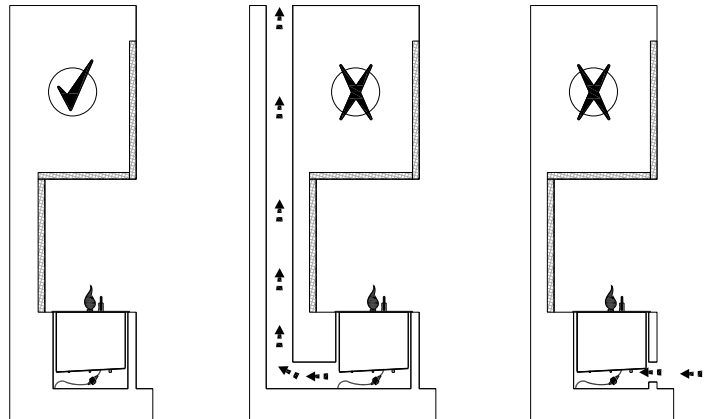

2.

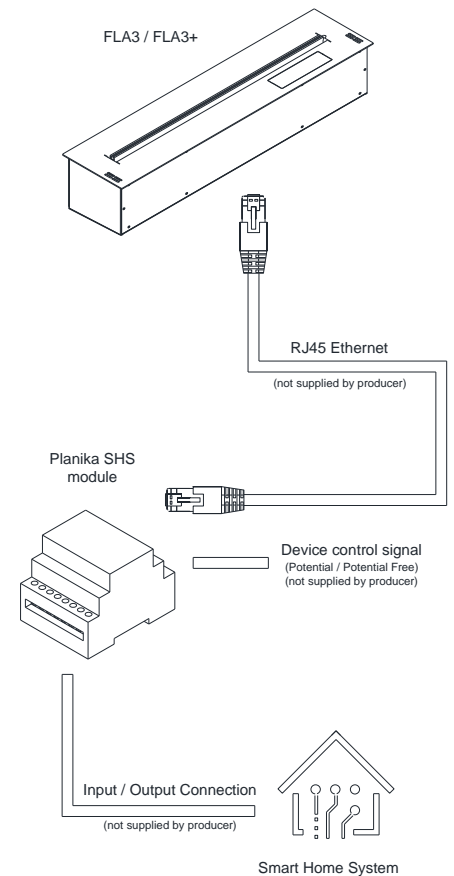
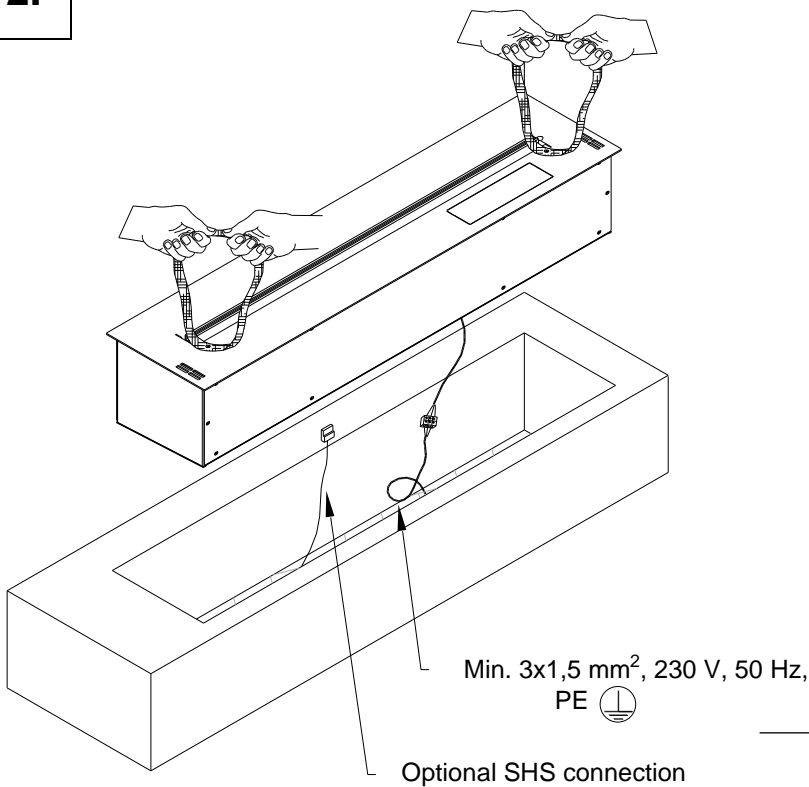

EN Selected installation options / **DE** Montagemöglichkeiten / **FR** Options de montage sélectionnées / **ES** Opci montaje seleccionadas /
IT Selezionate opzioni di montaggio / **PL** Wybrane możliwości montażu / **RU** Варианты размещения

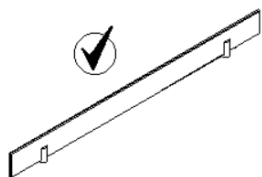

EN GLASS SHIELD (B)
DE TECHNISCHES GLAS (B)
FR VITR TECHNIQUE (B)
ES VIDRIO PROTECTOR (B)
IT VETRO PROTETTIVO (B)
PL SZYBKA TECHNICZNA (B)
RU ТЕХНИЧЕСКОЕ СТЕКЛО (B)

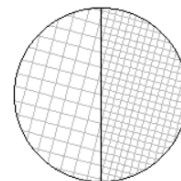

EN NON-FLAMMABLE MATERIAL
DE NICHT BRENNBARE MATERIALIEN
FR MATÉRIAU NON INFLAMMABLE
ES MATERIAL NO INFLAMABLE
IT MATERIALE NON INFIAMMABILE
PL MATERIAŁ NIEPALNY
RU НЕВОСПЛАМЕНЯЮЩИЙСЯ МАТЕРИАЛ

8

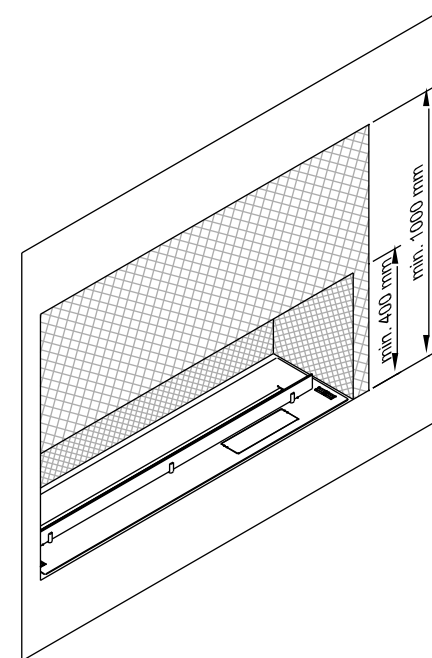
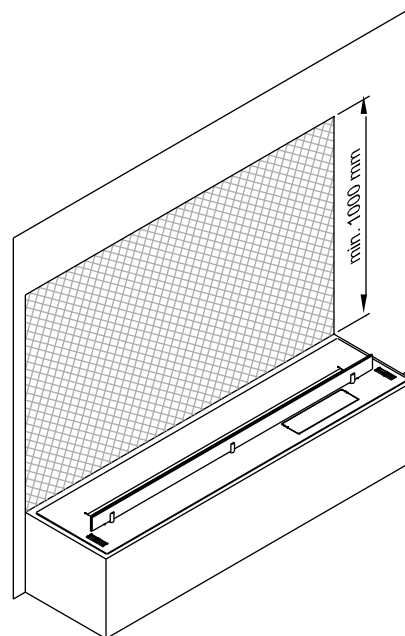
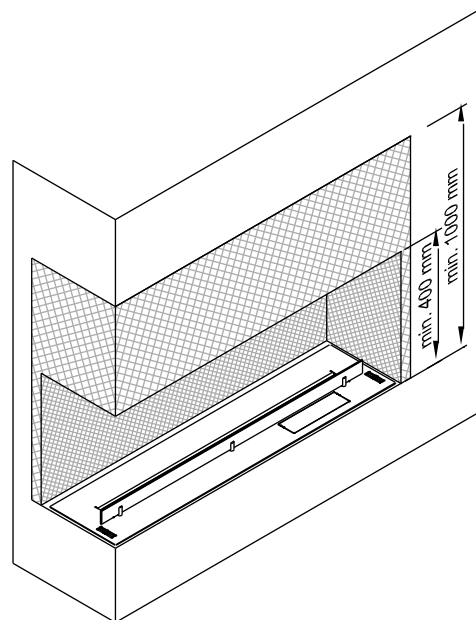
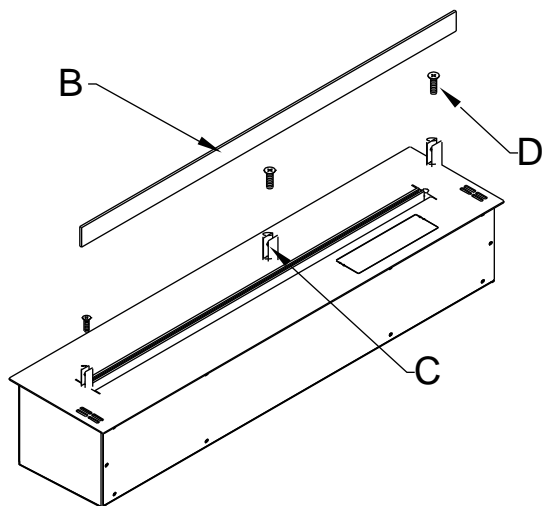

EN Selected installation options / DE Montagemöglichkeiten / FR Options de montage sélectionnées / ES Opci montaje seleccionadas / IT Selezionate opzioni di montaggio / PL Wybrane możliwości montażu / RU Варианты размещения

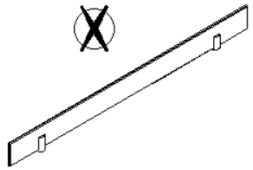

EN GLASS SHIELD (B)
DE TECHNISCHES GLAS (B)
FR VITR TECHNIQUE (B)
ES VIDRIO PROTECTOR (B)
IT VETRO PROTETTIVO (B)
PL SZYBKA TECHNICZNA (B)
RU ТЕХНИЧЕСКОЕ СТЕКЛО (B)

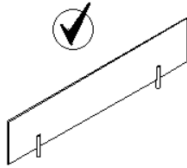

EN OPTIONAL TEMPERED GLASS PANEL (I)
DE GLAS PANEL (I)
FR PANNEAU EN VERRE (I)
ES PANEL DE VIDRIO (I)
IT PANNELLO DI VETRO (I)
PL PANEL SZKŁANY (I)
RU СТЕКЛЯННАЯ ПАНЕЛЬ (I)

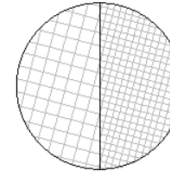

EN NON-FLAMMABLE MATERIAL
DE NICHT BRENNBARE MATERIALIEN
FR MATÉRIAU NON INFLAMMABLE
ES MATERIAL NO INFLAMMABLE
IT MATERIALE NON INFIAMMABILE
PL MATERIAŁ NIEPALNY
RU НЕВОСПЛАМЕНЯЮЩИЙСЯ МАТЕРИАЛ

6

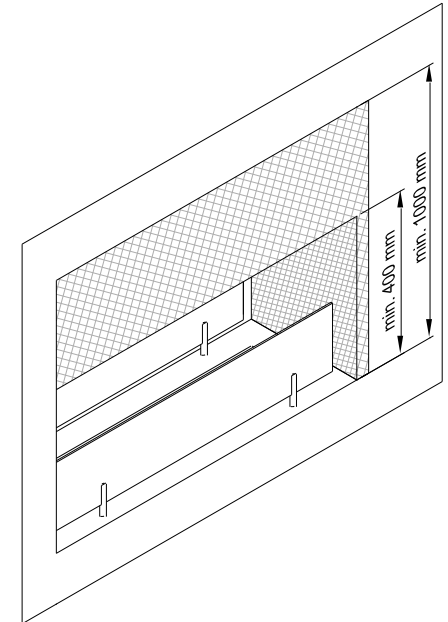
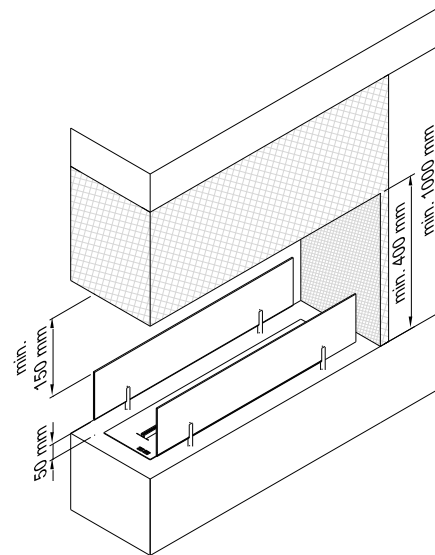
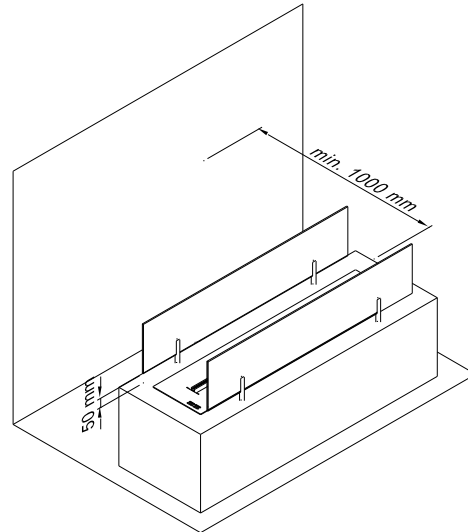
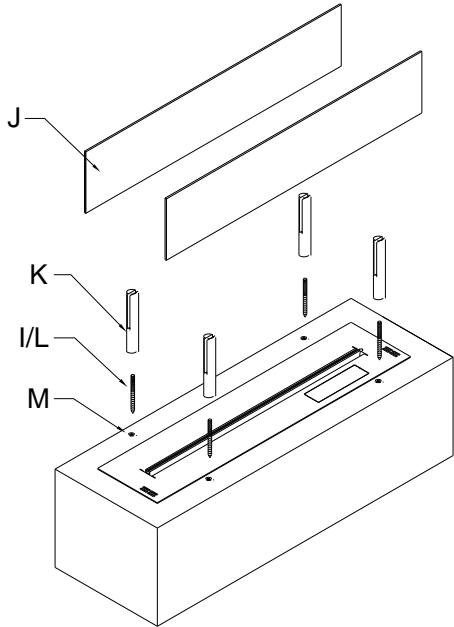

TV

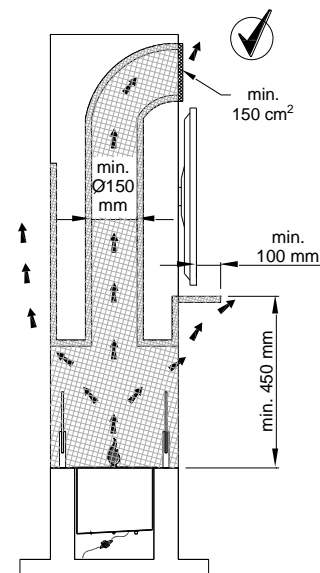
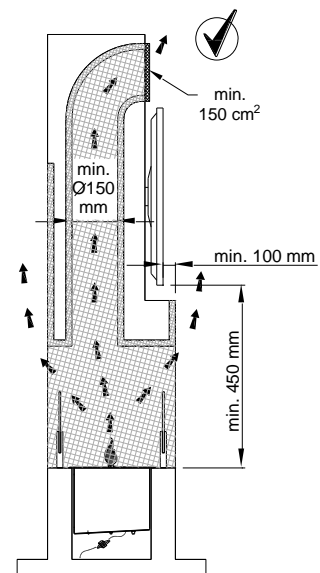
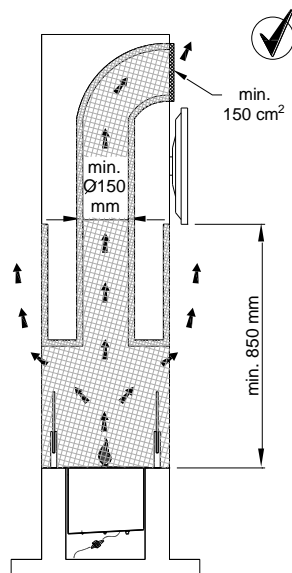
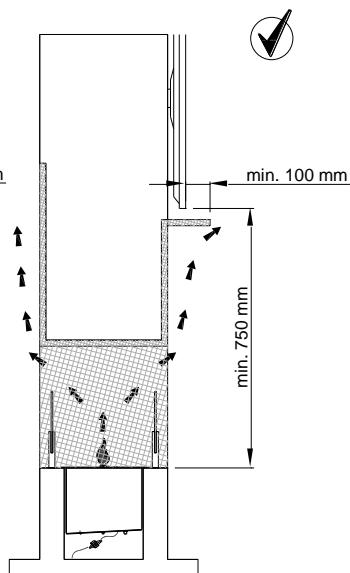
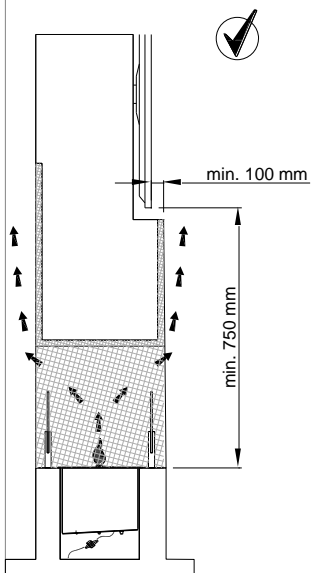
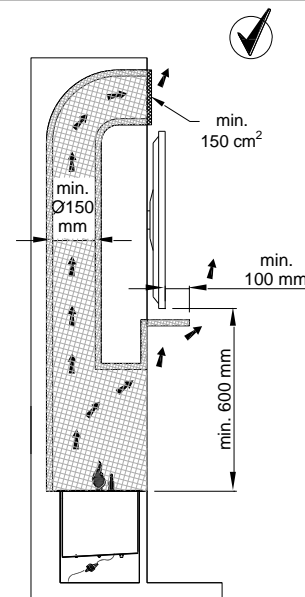
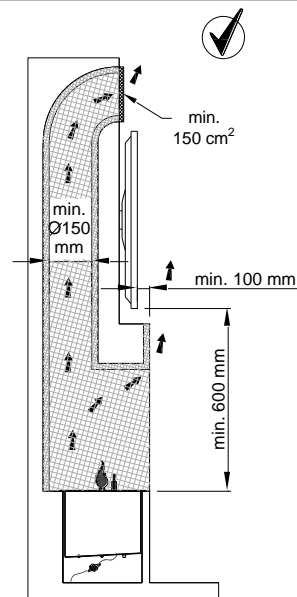
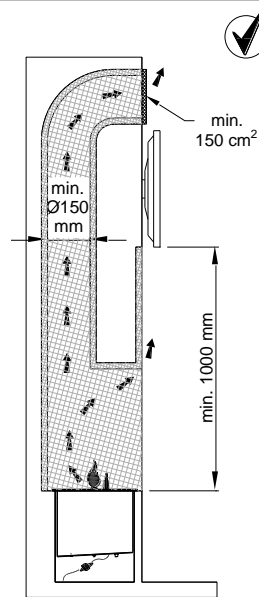
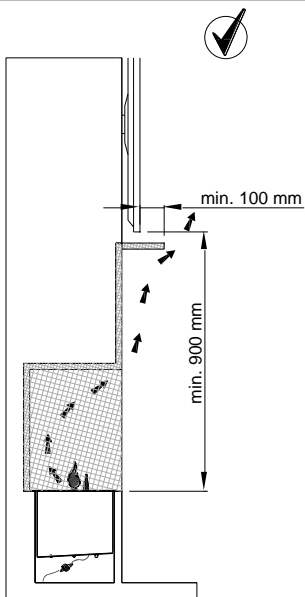
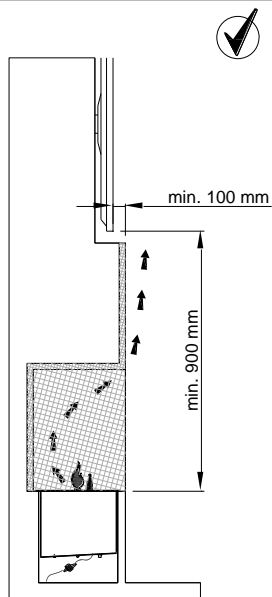
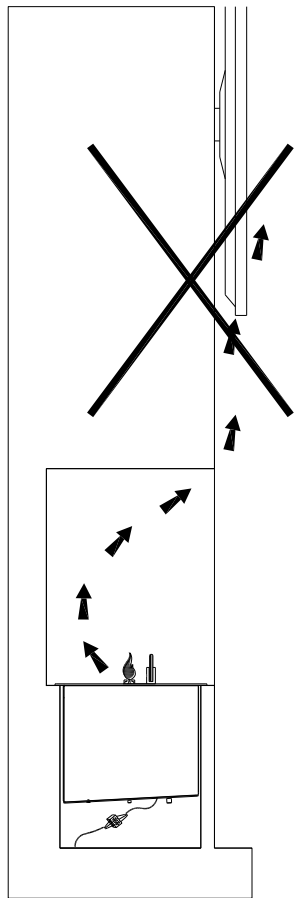

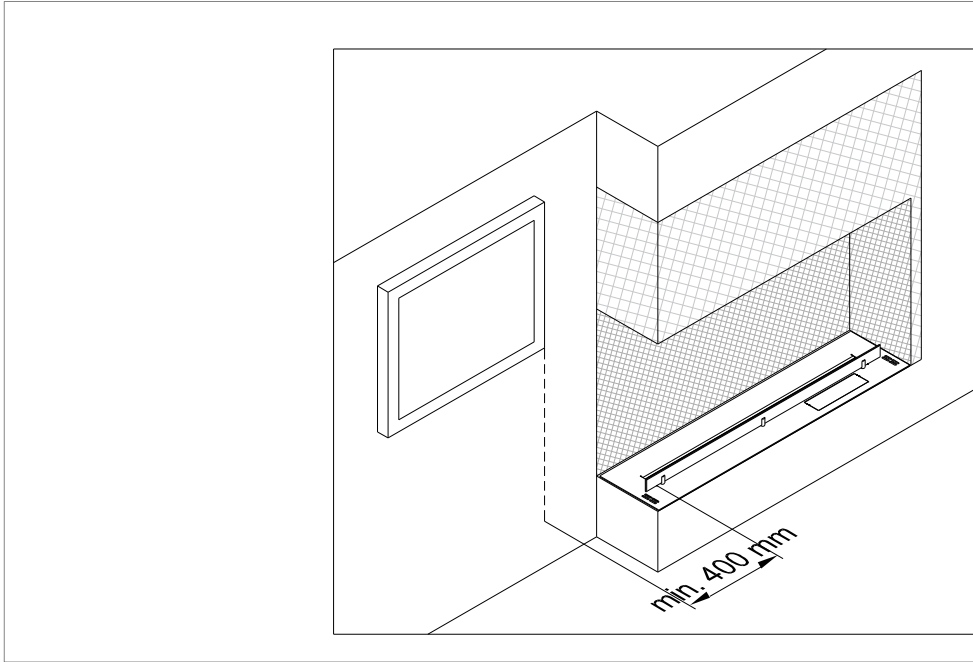

TV

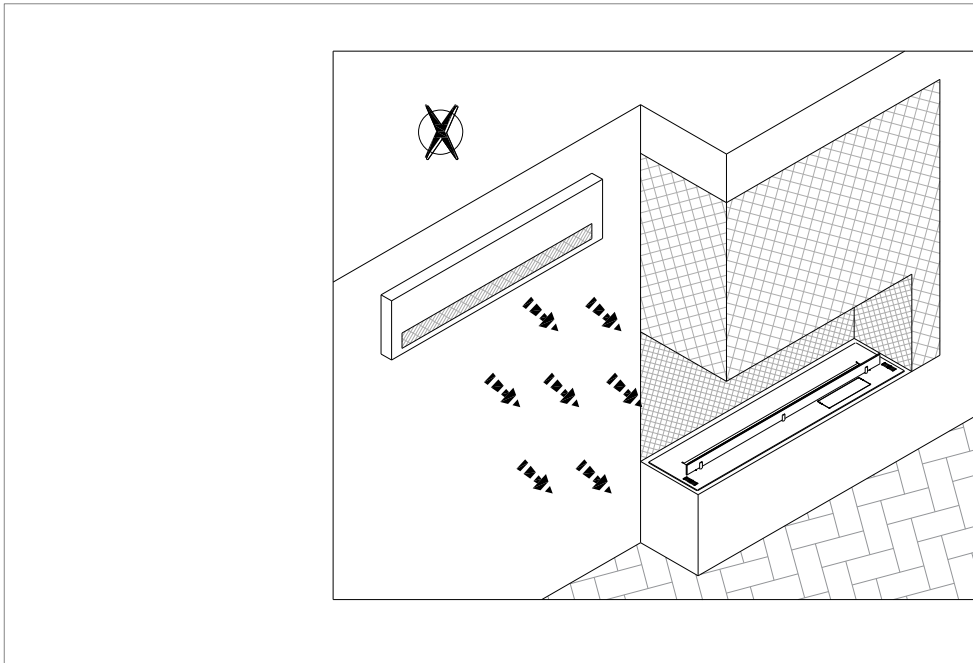
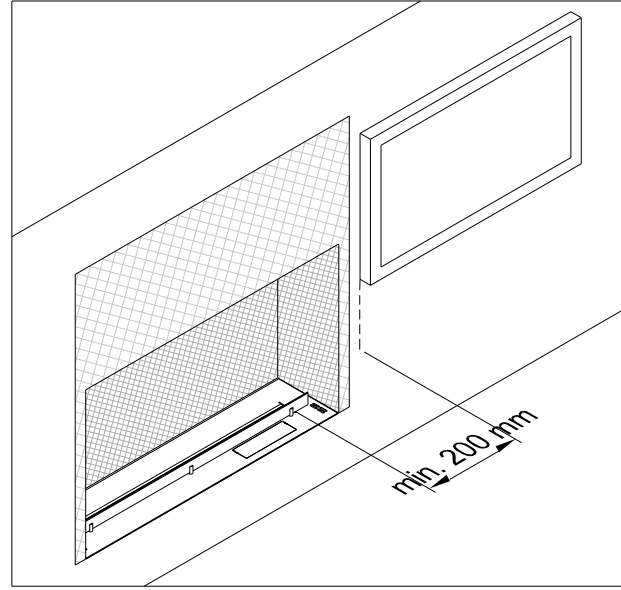

AC

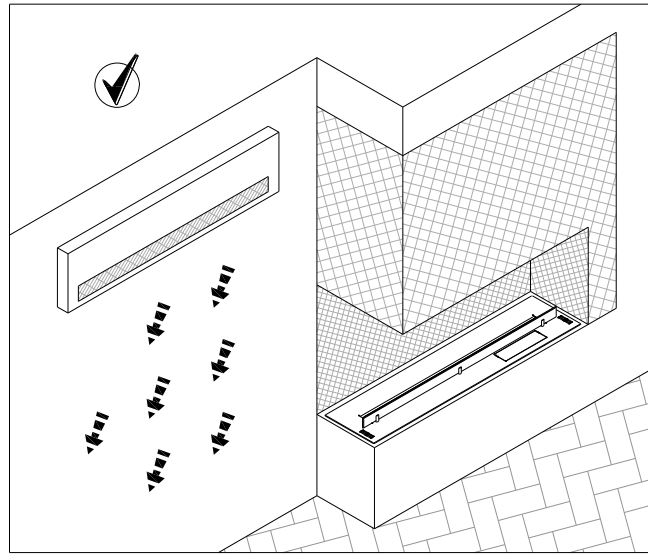

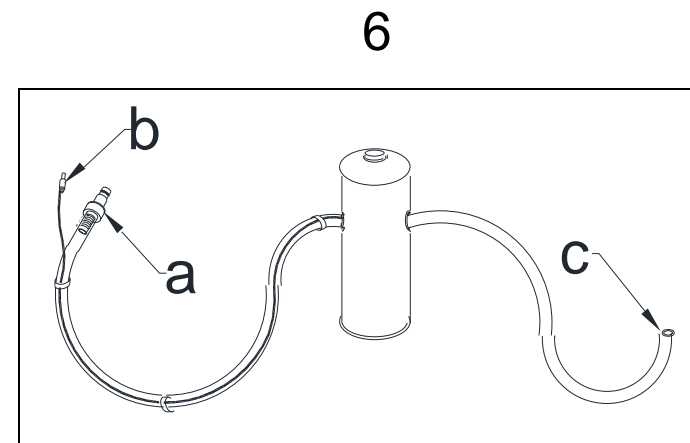
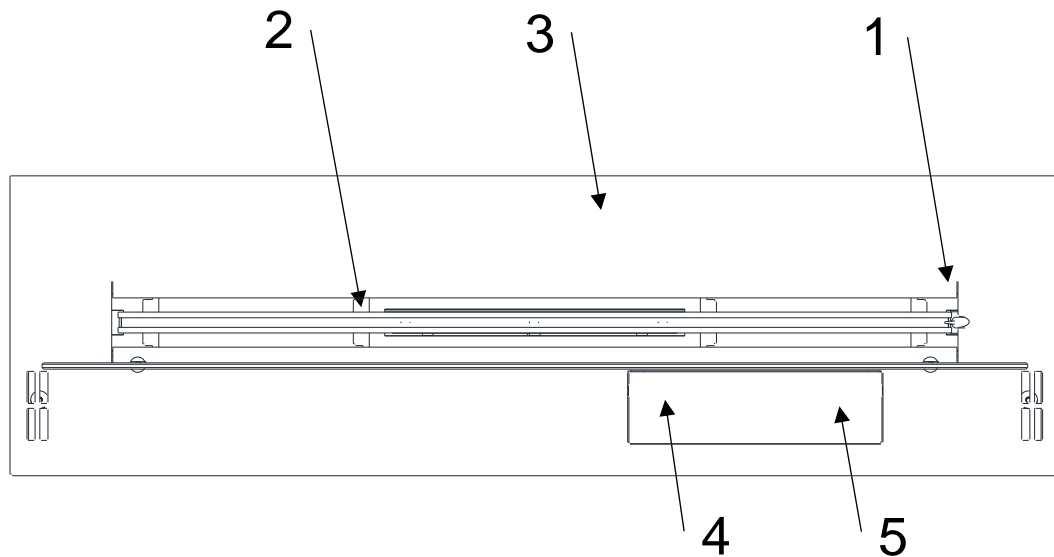

EN	DE	ES	FR
<ol style="list-style-type: none"> 1. Filament 2. Burner 3. Device surface 4. Control panel 5. Fuel filler 6. Fuel pump (a, b, c) 	<ol style="list-style-type: none"> 1. Glühelement 2. Feuerungsleiste 3. Feuerungsrost 4. Bedienpanel 5. Brennstofftanköffnung 6. Brennstoffpumpe (a, b, c) 	<ol style="list-style-type: none"> 1. Filamento 2. Hogar 3. Rejilla 4. Panel de control 5. Llenado de combustible 6. Bomba (a, b, c) 	<ol style="list-style-type: none"> 1. Filament 2. Foyer 3. Brûleur 4. Panneau de commande 5. Remplissage 6. Pompe (a, b, c)
IT	PL	RU	
<ol style="list-style-type: none"> 1. Resistenza 2. Focolare 3. Bruciatore 4. Pannello di controllo 5. Bocchettone di riempimento 6. Pompa di rifornimento (a, b, c) 	<ol style="list-style-type: none"> 1. Żarnik 2. Palenisko 3. Ruszt 4. Panel sterowania 5. Wlew paliwa 6. Pompa paliwa (a, b, c) 	<ol style="list-style-type: none"> 1. Нить накаливания 2. Желоб пламени 3. Верхняя плита 4. Панель управления 5. Отверстие для наполнения топливом 6. топливный насос (a, b, c) 	

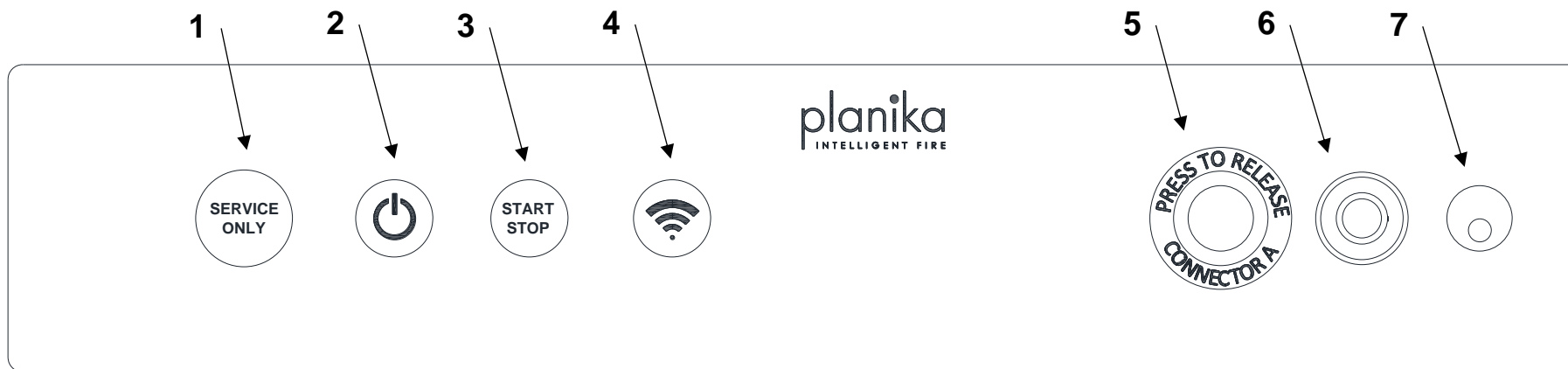

EN	DE	ES	FR
<ol style="list-style-type: none"> 1. Service port 2. Power ON/OFF 3. Flame START/STOP 4. Wi-Fi configuration/status 5. Fuel pump release 6. Fuel pump coupling 7. Fuel pump power socket 	<ol style="list-style-type: none"> 1. Service-USB-Eingang 2. Ein – und Ausschalten des Kamins 3. Anzünden und Erlöschen der Flamme 4. Konfiguration / WIFI Status 5. Knopf zum befreien der Pumpe 6. Anschluss der Brennstoffpumpe 7. Netzanschluss der Brennstoffpumpe 	<ol style="list-style-type: none"> 1. Puerto de servicio 2. Iniciar / apagar el dispositivo 3. Encender / apagar el dispositivo 4. Configuración / estado de WIFI 5. Botón de liberación de la bomba 6. Conector de la bomba de combustible 7. Suministro de bomba de combustible 	<ol style="list-style-type: none"> 1. Prise de service 2. Allumer/éteindre l'appareil 3. Allumer / éteindre la flamme 4. Configuration/état WIFI 5. Bouton de déverrouillage de la pompe 6. Connecteur de pompe à carburant 7. Alimentation de la pompe à carburant
IT	PL	RU	
<ol style="list-style-type: none"> 1. Presa USB 2. Accensione/spengimento del dispositivo 3. Accensione/spengimento della fiamma 4. Configurazione/stato WIFI 5. Pulsante di rilascio della pompa 6. Connettore della pompa di combustibile 7. Alimentazione della pompa di combustibile 	<ol style="list-style-type: none"> 1. Gniazdo serwisowe 2. Włączenie / wyłączenie urządzenia 3. Odpalenie / wygaszanie płomienia 4. Konfiguracja / status WIFI 5. Przycisk zwalniający pompę 6. Złącze pompy paliwa 7. Zasilanie pompy paliwa 	<ol style="list-style-type: none"> 1. Сервисный порт для подключения кабеля 2. Включение / выключение устройства 3. Розжиг / тушение пламени 4. Конфигурация / статус WIFI 5. Кнопка спуска насоса 6. Разъем топливного насоса 7. Разъем кабеля питания топливного насоса 	

REFUELLING

1. Open the lid (I) and turn the device on by pressing .
2. If the fuel tank is empty (**START/STOP BUTTON BLUE LIGHT ON**) or you want to refuel the fireplace, firmly plug in the fuel pump inlet 'a' (you will hear a click sound) and the power cord 'b' (II) (**BLUE LIGHT FLASHING**).

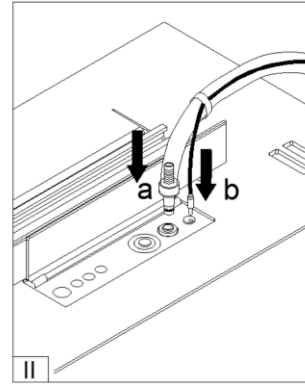
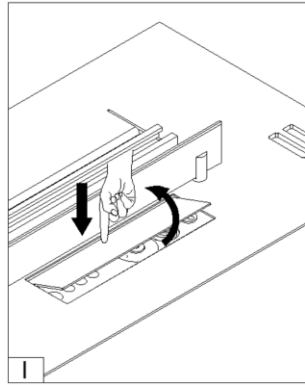

3. If the fuel bottle is secured with the flame restrictor (cap on the bottles' neck) (III) please remove it before inserting the fuel pump inlet (IV) Place the fuel container stably on the floor and insert the pump hose 'c' (IV). Press and hold the button on the pump to start refuelling (V).

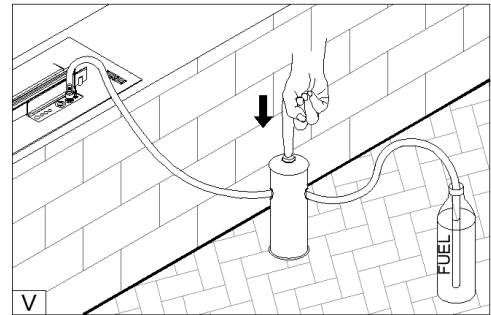
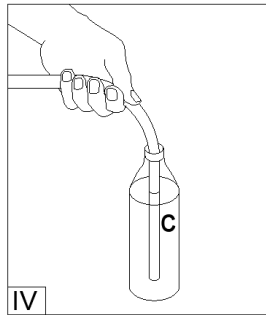
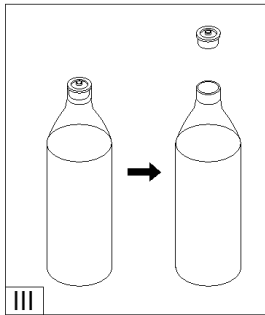

When the fuel bottle is empty, replace it with a full one and continue using the pump (see: section 3 above). The pump will stop refilling when the fuel tank is full (you will hear a beep).

4. Unplug the power cord 'b'. To unplug the pump, hold the pump inlet 'a' and firmly press the release button (VI).
5. Shake the remaining fuel from the hose 'c' to the container and place the pump in the bag (VII).

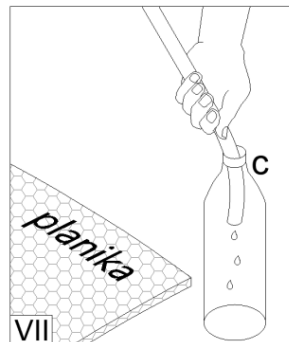
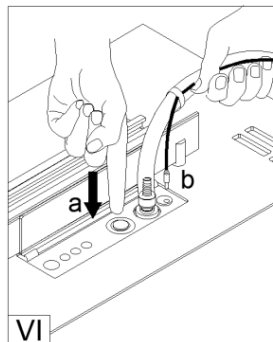



FLAME IGNITION

When the **START/STOP** button is lit up in green, the device is ready to be launched.

Press **START**. Firing up of the device takes from 2 to 10 minutes (**FLASHING GREEN LIGHT**). During the process of firing up, scent of fumes can be present. When the lights stop flashing, the device is lit up and has reached the working temperature.

FLAME HEIGHT REGULATION

When the flame is on, press the  or  button on the remote or scroll the flame level bar in the mobile app to choose one of the six flame heights. The flame starts on height 4 by default.

NOTE. In case of too high a temperature of the device, the flame height will be automatically decreased and locked from changing. If the temperature continues to increase, the flame will be extinguished (**RED LIGHT**)

FLAME EXTINGUISHING

To extinguish the flame:

-press **STOP**. When the flame is being extinguished, additional fans are turned on to speed up the cooling process.

Flashing red light indicated the device being cooled. Restarting the flame is possible only after complete cooldown of the device (**GREEN LIGHT**).



TURNING THE DEVICE OFF

To turn the device OFF, press .

The device will automatically turn off in case of any work related errors. (check the error in the mobile app).

WIRELESS CONTROL CONFIGURATION

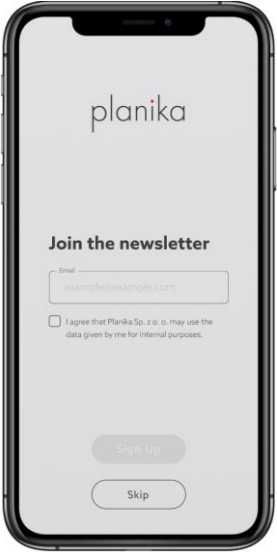
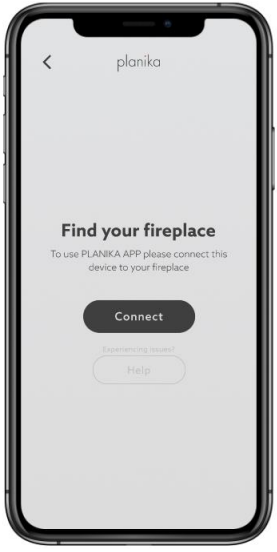

To pair the device with the mobile app (simultaneous pairing of more than one device is not possible):

<p style="text-align: center;">Join the newsletter</p> <p>1. Launch the FLA3 NET-ZERO mobile app. Join the newsletter by submitting your e-mail address and pressing SIGN UP or simply press SKIP.</p> <p style="display: flex; justify-content: space-around; font-size: small;"> Google play Appstore </p> <div style="display: flex; justify-content: space-around;">   </div>		<p style="text-align: center;">Find your fireplace</p> <p>2. On the FIND YOUR FIREPLACE screen press CONNECT to start the network search.</p>	
---	--	--	--

3. Press and hold the WiFi button  on the fireplace. When the button starts flashing, the fireplace is ready to be paired for 5 minutes.

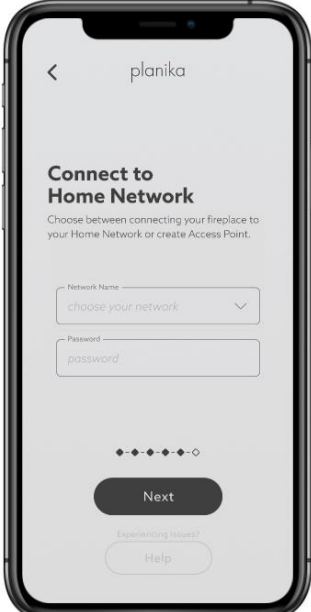

<p style="text-align: center;">Setup Network Active</p> <p>4. Go to mobile device setup, turn on the WiFi network and connect with Fireplace_WiFi_setup(if the network is not visible, unplug the device for 10 seconds and retry the configuration). The fireplace will be automatically found by the mobile app, which will be confirmed by the app (SETUP NETWORK ACTIVE). Press CONNECT.</p>		<p style="text-align: center;">Connect to Home Network</p> <p>5. On the CONNECT TO HOME NETWORK screen, choose the name of the network which you plan to use by default (NETWORK NAME) and submit its password. Make sure the password is correct and hit (SUBMIT).</p>	
--	---	---	---



Your fireplaces		Access Point	
<p>6. On the following screen (YOUR FIREPLACES), choose your device and press CONNECT. The screen also allows you to change the name of the fireplace (EDIT).</p>		<p>7. You can also create a dedicated network ACCESS POINT and connect directly with the device. To do that, press (HELP), choose (CONNECTION TYPE), and (ACCESS POINT), then confirm by pressing (CREATE ACCESS POINT). Submit new name for the network and the password. Confirm by pressing NEXT.</p>	

After successful configuration, the WiFi button will light up in green.



FLA3 NET-ZERO MOBILE APP



	<ol style="list-style-type: none"> 1. Newsletter 2. Fireplace status 3. Fuel level 4. Flame height 5. Start and stop 6. Info 7. Menu
--	---

MENU

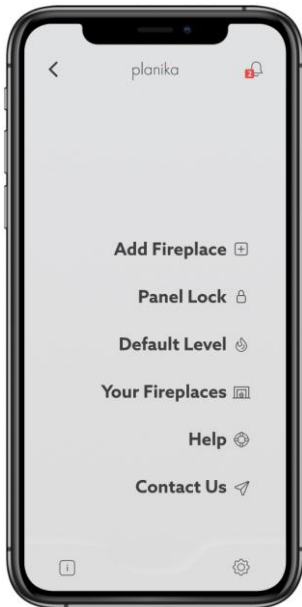

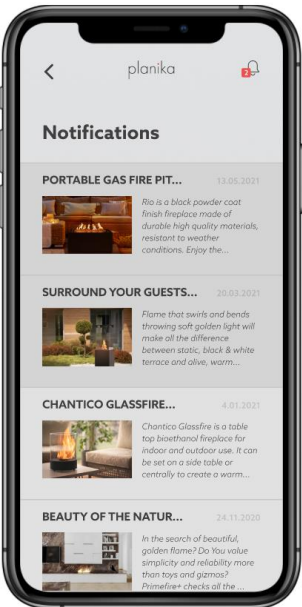
To access menu, press the  button. To go back to the main panel, press **BACK** 

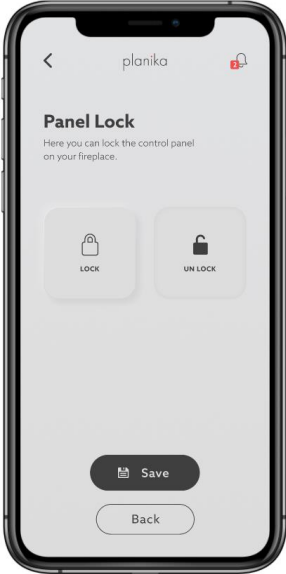
To access general information about the fireplace, press the  button. The newsletter is available after pressing the  button.

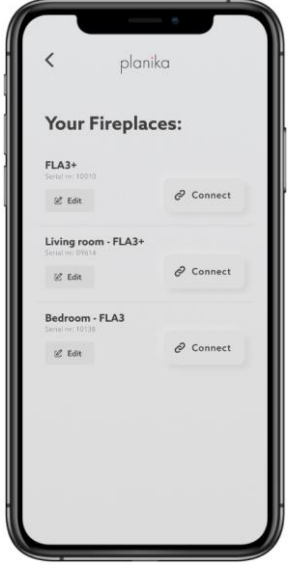
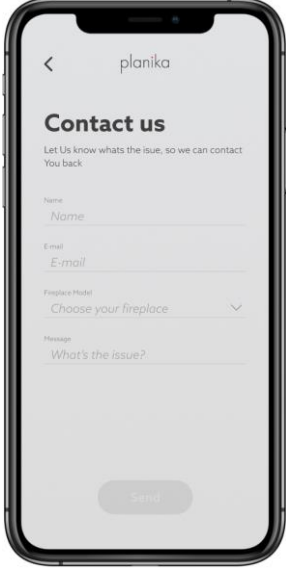



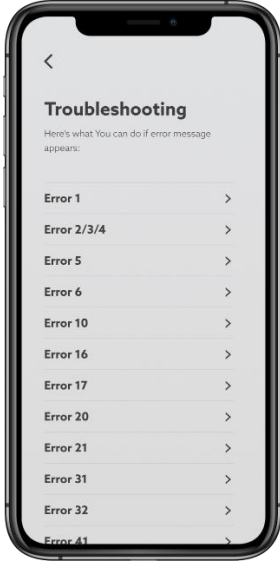

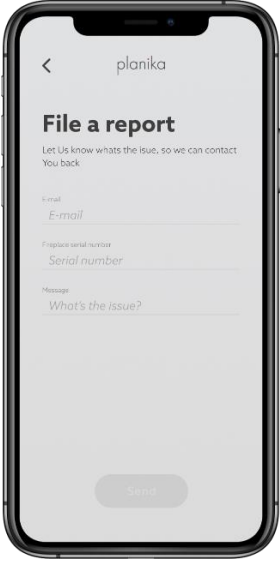







Menu	Info	Newsletter
		
<p>Main app setup. Press the tab to change the settings.</p>	<p>Press to check the general information of the fireplace</p>	<p>Press to check the notifications</p>

Panel Lock	Default Level	Your fireplaces	Contact us
			
<p>Press LOCK to lock the control panel on the fireplace. Press UNLOCK to unlock the control panel on the fireplace. Confirm by clicking SAVE. The change is possible with the fireplace off only.</p>	<p>Change the default launch flame height. Press SAVE to confirm the change. Press RESET to reset your choice. The default setting of the flame is height 4.</p>	<p>Check available fireplaces. Press EDIT to change the device name. Press CONNECT to connect to the device.</p>	<p>Contact Planika by e-mail. Press SEND to send us an e-mail.</p>

ERRORS

Help	Error	File a Report
		
<p>Press HELP in the main MENU to access the Troubleshooting tab.</p>	<p>Fix the error with the provided information. If the error proceeds to appear, contact us by pressing REPORT.</p>	<p>If still in need of service, send us a message with a short description of the problem and general information. Press SEND.</p>

INFORMATION SIGNALS

POWER DIODE	START/STOP DIODE	SOUND	ACTION	COMMUNICATION
		-	Green light	Device turned off
		-	Green light	Device is ready to work
		-	Green blinking	Starting procedure
		-		Working
		-	Blue light	No fuel - Refuel
		-	Blue blinking	Refueling
			Blue blinking with sound	Full tank
			Red light with sound	Extinguishing, cooling
			Purple light with sound	Error – check the app (troubleshooting) and contact with service
		-	Blue, red blinking	Fuel tank is empty
WI-FI DIODE			ACTION	COMMUNICATION
			Blue light	Not connected to wi-fi
			Blue blinking	Pairing / configuration
			Green light	Wi-fi connected

FUEL - Use only ethanol fuel produced from plants in the process of two-time alcohol distillation consisting of 95-96.6% ethanol by volume. Fanola is the recommended fuel with pharmacological purity.

DO NOT USE SYNTHETIC PETROLEUM BASED FUELS AS THEY ARE CONTAMINATED, EMIT UNPLEASANT ODORS AND CAN DAMAGE THE FIREPLACE! DO NOT USE FUELS CONTAINING 100% ETHANOL BY VOLUME, GEL, OR AROMATIC FUELS!

CLEANING – Clean with a damp cloth and delicate detergents, only when the device is turned off and cooled.

SERVICE – Keep the provided USB cable for service. Reach out to us at service@planikafires.com.

BRENNSTOFFNACHFÜLLEN

1. Öffnen Sie die Klappe des Bedienpanels und Einfüllklappe (I) und drücken Sie  um den Kamin einzuschalten.
2. Ist der Brennstofftank leer (**START/STOP TASTE MIT BLAUER LEUCHTDIODE**) oder möchten Sie den Brennstoff nachfüllen, klemmen Sie mit einer sicheren Bewegung den Pumpenschlauch 'a' (Sie werden einen Klick hören) und den Netzkabel an 'b' (II) (**BLAUE LEUCHTDIODE BLINKT**).

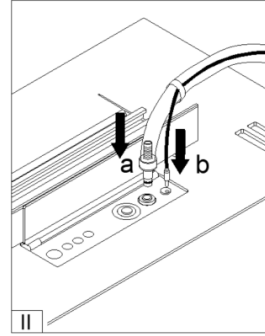
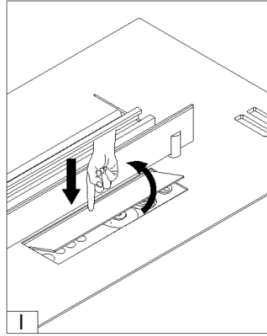

3. Wenn die Flasche mit Ethanol mit einem zusätzlichen Schutzkorken ausgestattet ist (III), muss man diesen entfernen, bevor man das Schlauchende von der Pumpe in die Flasche reinsetzt (IV). Stellen Sie den Brennstoffbehälter stabil auf den Boden und fügen den Schlauch hinein 'c' (IV). Drücken Sie den Knopf auf der Pumpe (V), um das Brennstoffnachfüllen zu beginnen.

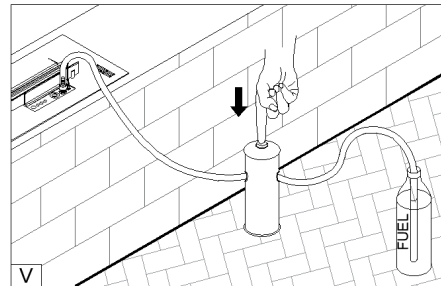
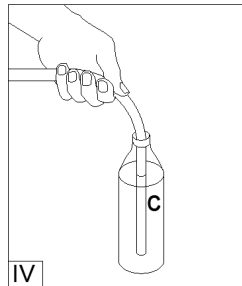
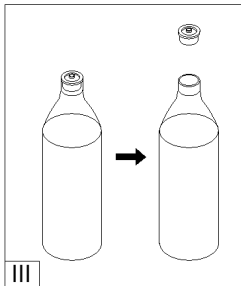

Wenn der Brennstoffbehälter leer ist, tauschen Sie ihn auf einen vollen aus und schalten die Pumpe wieder ein (siehe Punkt 3). Die Pumpe wird automatisch ausgeschaltet, sobald der Brennstoffbehälter voll ist (**SIGNALTON**).

4. Trennen Sie den Netzkabel vom Gerät 'b'. Um die Pumpe 'a' abzulösen, halten Sie das Ende des Schlauches 'a' und drücken kräftig die, mit dem Aufkleber gekennzeichnete Taste (VI).
5. Schütten Sie den restlichen Kraftstoff vom Pumpenschlauch 'c' in den Behälter ein und stecken die Pumpe in die Pumpeschutzhülle (VII).

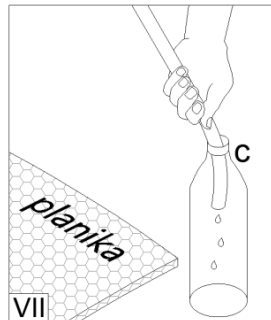
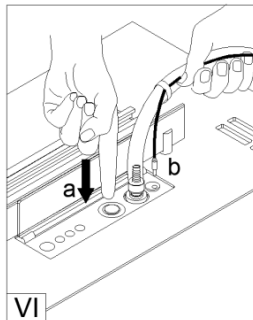



FLAMMENZÜNDUNG

Die grün beleuchtete Taste **START / STOP** heisst, dass das Gerät bereit ist um die Flammenzündung zu starten.

Drücken Sie **START**. Die Flammenzündung dauert 2-10 Minuten (**BLINKENDE GRÜNE LEUCHTDIODE**). In dieser Zeit kann der Geruch von Kraftstoffdämpfen zu spüren sein. Das Erlöschen der Leuchtdioden ist eine Information, dass die Flamme gezündet wurde und der Kamin die Betriebstemperatur erreicht hat.

REGULIERUNG DER FLAMMENHÖHE

Wenn die Flamme brennt, drücken Sie  oder  auf der Fernbedienung oder den Flammenpegelbalken verschieben in der Applikation, um die Flammenhöhe auf 6 Niveaus zu vergrössern oder zu verkleinern. Das Gerät schaltet sich standardmässig mit einer Flammenhöhe auf dem 4 Niveau.

ACHTUNG! Falls der Kamin zu hohe Temperatur erreicht, wird die Flamme automatisch verringert und die Möglichkeit die Flammenhöhe zu ändern wird blockiert. Falls die Temperatur weiter ansteigen wird, wird die Flamme ausgelöscht (**ROTE LEUCHTDIODE**).

FLAMMENAUSLÖSCHUNG

Um die Flamme auszulöschen:

- drücken Sie **STOP**. In diesem Fall, schalten sich die Ventilatoren ein, die die Abkühlung des Gerätes zu beschleunigen.

Blinkende rote Leuchtdiode bedeutet, dass das Gerät gekühlt wird. Die erneute Flammenzündung ist erst nach Abkühlung des Gerätes möglich (**GRÜNE LEUCHTDIODE**).







AUSSCHALTUNG DES GERÄTES

Um das Gerät vollständig auszuschalten, drücken Sie .

Das Gerät wird sich automatisch ausschalten, wenn irgendwelche Fehler im Arbeitsmodus auftreten (überprüfen Sie den Fehler in der Applikation).

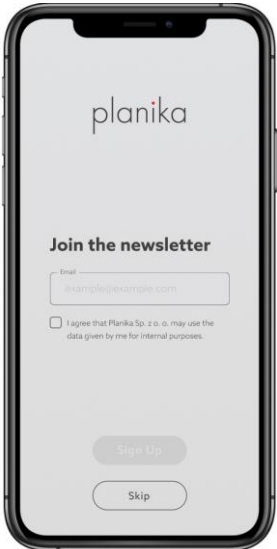
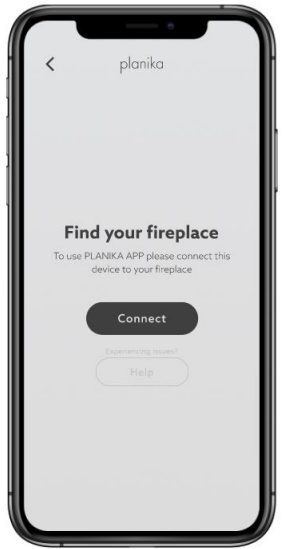
KONFIGURATION DER DRAHTLOSEN VERBINDUNG

Paarung des Gerätes mit der Applikation wird folgend durchgeführt (gleichzeitig kann nur ein Gerät gepaart werden):

<p>Join the newsletter</p> <p>1. Schalten Sie bitte die FLA3 NET-ZERO Applikation auf dem Handy ein. Bestätigen Sie den Wunsch des Beitritts zum Newsletter, indem Sie die E-Mailadresse eintragen und auf SIGN UP drücken oder übergehen Sie zum SKIP</p> <p>Google play Appstore</p>  		<p>Find your fireplace</p> <p>2. Auf dem Bildschirm zeigt sich FIND YOUR FIREPLACE. Drücken Sie CONNECT um die Netzsuche zu starten.</p>	
<p>3. Drücken Sie und halten die WIFI - Taste  auf dem Kamin. Das Blinken der Taste bedeutet, dass das Gerät zur Paarung bereit ist. Im Fall, das keine Aktivität stattfindet, wird die Bereitschaft nach 5 Minuten annulliert.</p>			
			
<p>Setup Network Active</p> <p>4. Gehen Sie zu den Einstellungen des Mobilgerätes, schalten Sie das WiFi ein und verbinden mit dem Netz Fireplace_WiFi_setup (wenn das Netz nicht zu sehen ist, schalten Sie die Stromversorgung des FLA Gerätes für 10 Sekunden ab und wiederholen Sie die Konfiguration. Der Kamin wird automatisch durch die Applikation aufgefunden. Dies wird durch die Information SETUP NETWORK ACTIVE bestätigt. Drücken Sie CONNECT.</p>		<p>Connect to Home Network</p> <p>5. Auf dem Bildschirm CONNECT TO HOME NETWORK wählen Sie den Netznamen, welchen Sie im Endeffekt benutzen möchten (NETWORK NAME) und geben deren Passwort ein. Überprüfen Sie, dass das Passwort richtig ist und drücken Sie (SUBMIT).</p>	



Your fireplaces		Access Point	
<p>6. Auf dem nächsten Bildschirm YOUR FIREPLACES, wählen Sie das Gerät aus und drücken CONNECT. Auf dem Bildschirm können Sie den Namen des Kamins anpassen, indem Sie auf EDIT drücken.</p>		<p>7. Wenn Sie keinen von den verfügbaren Netzen verwenden möchten, können Sie ein gewidmetes Netz erschaffen durch ACCESS POINT und sich direkt mit dem Gerät zu verbinden. Um dies zu tun, drücken Sie (HELP), wählen (CONNECTION TYPE) und nachhinein (ACCESS POINT) mit drücken des (CREATE ACCESS POINT) zu bestätigen. Fügen Sie den Netznamen und das Passwort ein, bestätigen Sie durch das drücken von NEXT.</p>	



Nach einer gelungenen Konfiguration wird die WIFI Leuchtdiode grün angezeigt.

APPLIKATION FLA3 NET-ZERO



	<ol style="list-style-type: none"> 1. Newsletter 2. Kaminmodus 3. Brennstoffniveau 4. Flammenhöhe 5. Flammenzündung und – auslöschung 6. Info 7. Menü
--	--

MENU

Das Menü ist erreichbar durch das Drücken der Ikone . Die Rückkehr zum Hauptpaneel ist möglich durch das Drücken der **ZURÜCK**  Taste.

Um die allgemeinen Informationen über den Kamin zu bekommen, drücken Sie . Das Newsletter ist erreichbar durch das Drücken auf die Ikone .

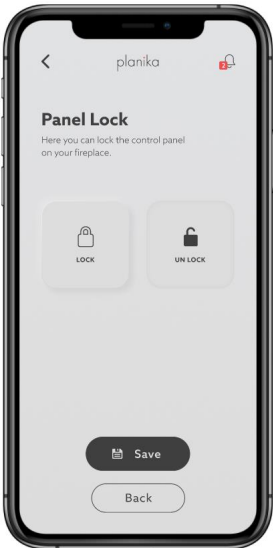

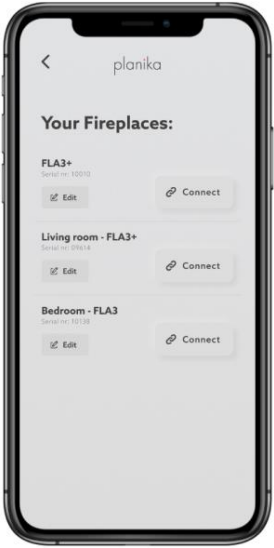
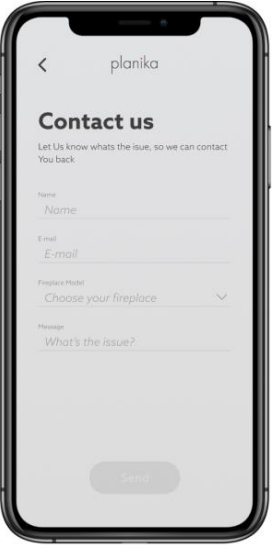
Menu	Info	Newsletter
		
<p>Haupteinstellungen der Applikation. Drücken Sie den Bookmark, um die Einstellungen zu ändern.</p>	<p>Drücken Sie, um die Hauptinformationen über den Kamin zu prüfen.</p>	<p>Drücken Sie, um Benachrichtigungen zu prüfen.</p>

Panel Lock	Default Level	Your fireplaces	Contact Us
			
<p>Drücken Sie LOCK, um den Steuerpaneel des Kamins zu blockieren. Drücken Sie UNLOCK, um den Steuerpaneel des Kamins freizuschalten. Bestätigen Sie die Auswahl durch das Drücken der SAVE Taste. Die Änderung ist nur bei dem erloschenen Gerät möglich.</p>	<p>Stellen Sie das Niveau der Flamme ein, auf dem der Kamin seine Arbeit anfangen wird nach dem Start. Drücken Sie SAVE, um die Änderungen zu speichern. RESET, um die Einstellungen neuzustarten. Das Gerät schaltet sich standardmäßig mit einer Flammenhöhe auf dem 4 Niveau.</p>	<p>Überprüfen Sie die verfügbaren Kamine. Drücken Sie EDIT, um den Namen des Gerätes zu ändern. Drücken Sie CONNECT, um sich mit dem Gerät zu verbinden.</p>	<p>Kontaktieren Sie Planika durch durch E-Mail. Drücken Sie SEND, um die Nachricht zu verschicken.</p>

ALARMMITTEILUNGEN

Help	Error	File a Report
		
<p>Drücken Sie HELP im MENU, um zum Bookmark Troubleshooting zu gelangen.</p>	<p>Führen Sie die Tätigkeit aus, die den Fehler betrifft. Wenn der ERROR weiterhin aufgezeigt wird, melden Sie die Angelegenheit durch das Drücken der REPORT Taste.</p>	<p>Wenn Sie weiterhin die Hilfe des Service benötigen, so senden Sie die Nachricht mit der Beschreibung des Fehlers und den Basisinformationen durch SEND.</p>

INFORMATIONSSIGNALE

STROM-DIODEN	START/STOPP-DIODE	TON	AKTION	KOMMUNIKATION
		-	Grüner Blitz	Gerät ist ausgeschaltet
		-	Grünes Blinken	Gerät ist einsatzbereit
		-	Grün blinkend	Startvorgang
		-		In Betrieb
		-	Blau blinken	Kein Kraftstoff - Tanken
		-	Blau blinkend	Tanken
			Blau blinkend mit Ton	Voller Tank
			Rotes Blinken mit Ton	Entlüften, Kühlen
			Lila blinken mit Ton	Fehler - App überprüfen (Fehlersuche) und Kontakt mit dem Service aufnehmen
		-	Blau, rot blinkend	Kraftstofftank ist leer
WI-FI DIODEN		AKTION		KOMMUNIKATION
			Blaues Blinken	Nicht mit Wi-Fi verbunden
			Blau blinkend	Kopplung/Konfiguration
			Grünes Blinken	Wi-fi verbunden

BRENNSTOFF - Verwenden Sie nur Ethanolkraftstoff, der aus Pflanzen im Prozess der zweimaligen Alkoholdestillation hergestellt wird und aus 95-96,6 Vol.-% Ethanol besteht. Fanola ist der empfohlene Brennstoff mit pharmakologischer Reinheit.

VERWENDEN SIE KEINE SYNTHETISCHEN BRENNSTOFFE AUF ERDÖLBASIS, DA DIESE VERUNREINIGT SIND, UNANGENEHME GERÜCHE ABGEBEN UND DEN KAMIN BESCHÄDIGEN KÖNNEN! VERWENDEN SIE KEINE KRAFTSTOFFE MIT 100 VOL.-% ETHANOL, GEL ODER AROMATISCHE KRAFTSTOFFE!

REINIGUNG – Mit einem feuchten Lappen und milden Reinigungsmittel reinigen, nur wenn der Kamin ausgeschaltet und abgekühlt ist.

SERVICE – Für Servicezwecke bewahren Sie das mitgelieferte USB-Kabel auf. Kontakt: service@planikafires.com

RELLENO DEL COMBUSTIBLE

1. Abra la tapa (I) y encienda el dispositivo presionando .
2. Si el tanque está vacío (**BOTÓN START/STOP ILUMINADO AZUL**) o desea añadir el combustible, conecte la manguera de la bomba 'a' con un cierto movimiento (escuchará un clic) y el cable de alimentación 'b' (II) (**LED AZUL PARPADEANDO**).

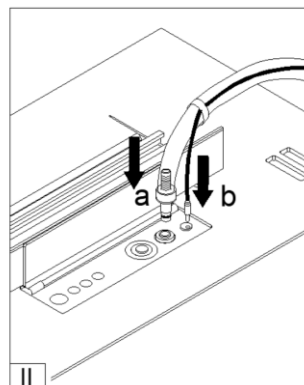
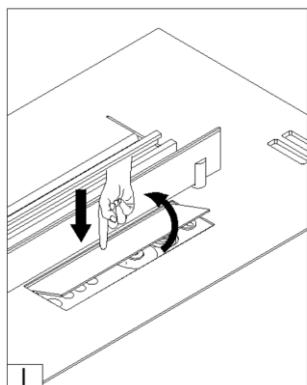

3. Si la botella de combustible está asegurada con el limitador (tapa en el cuello de las botellas) (III), retírela antes de insertar la entrada de la bomba de combustible (IV). Coloque el recipiente con el combustible en el suelo y coloque la manguera de la bomba 'c' (IV) . Mantenga presionado el botón de la bomba (V) para comenzar a verter.

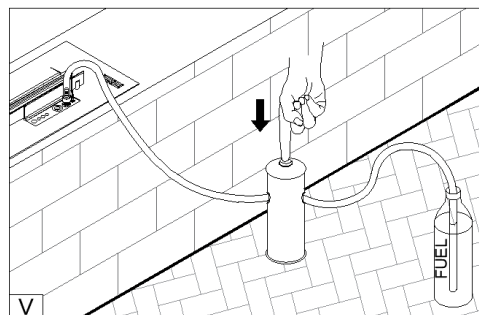
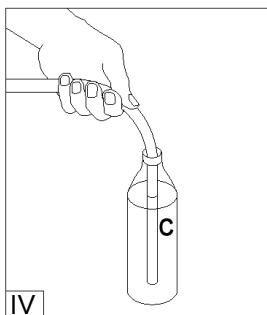
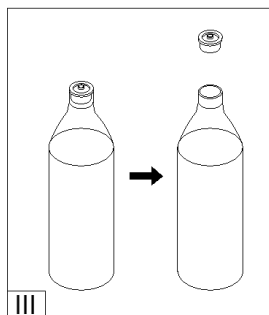

Cuando el depósito de combustible esté vacío, sustitúyalo por uno lleno y reinicie la bomba (consulte el punto 3). La bomba se apagará cuando el tanque de combustible esté lleno (señal acústica).

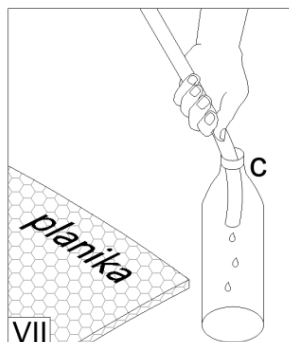
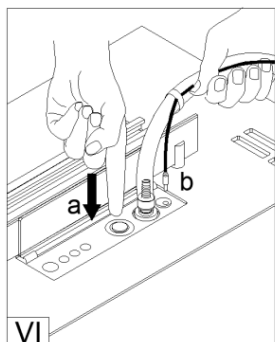

4. Desconecte el cable de alimentación 'b'. Para quitar la bomba, sostenga el extremo de la manguera y presione el botón en el lugar marcado con una pegatina (VI).
5. Sacuda el combustible restante de la manguera 'c' en la botella y coloque la bomba en la tapa (VII).



ENCENDIDO DE LA LLAMA

El botón **START / STOP** iluminado en verde significa que el dispositivo está listo para encender la llama. Presiona **START**. Se tarda entre 2 y 10 minutos en encender la llama (**LED VERDE PARPADEANDO**). Durante este tiempo, puede oler los vapores del combustible. Los diodos de extinción informan que la llama se ha encendido y el dispositivo ha alcanzado su temperatura de funcionamiento.

REGULACIÓN DE LA ALTURA DE LLAMA

Mientras la llama está encendida, presione  o  en el control remoto o desplazar la barra de nivel de llama en la aplicación para aumentar o disminuir su altura en 6 niveles. La llama se dispara a la 4ª altitud de forma predeterminada. **¡ATENCIÓN!** En caso de una temperatura demasiado alta del dispositivo, la altura de la llama se reducirá automáticamente y se bloqueará su ajuste. Si la temperatura sigue subiendo, la llama se apagará (**LED ROJO**)

APAGAR LA LLAMA

Para apagar la llama:

- presione **STOP**. En este caso, los ventiladores se encenderán adicionalmente para acelerar el enfriamiento del dispositivo. **LED ROJO parpadeante** significa que el dispositivo se está enfriando. El reencendido de la llama solo es posible después de que el dispositivo se haya enfriado (**LED VERDE**).

APAGAR EL DISPOSITIVO

Para apagar el dispositivo por completo, presione .

El dispositivo se apagará automáticamente en caso de detectar algún mal funcionamiento (verifique el error en la aplicación).

CONFIGURACIÓN LA COMUNICACIÓN INALÁMBRICA

El dispositivo se configura con la aplicación de la siguiente manera (solo se puede configurar un dispositivo a la vez):

<p>Join the newsletter</p> <p>1. Inicie las FLA3 NET-ZERO aplicaciones en el teléfono. Confirme su voluntad de unirse al boletín ingresando su dirección de correo electrónico y haciendo clic en SIGN UP o salte la etapa haciendo clic en SKIP</p> <p>Google play Appstore</p>  		<p>Find your fireplace</p> <p>2. En la pantalla FIND YOUR FIREPLACE, haga clic en CONNECT para comenzar a buscar una red.</p>	
---	--	--	--

3. Mantenga presionado el botón **WIFI**  en la chimenea. El parpadeo del botón significa que la chimenea está lista para configurarse. El modo de espera se cancelará después de 5 minutos en caso de inactividad.



<p>Setup Network Active</p> <p>4. Vaya a la configuración del dispositivo móvil, encienda la red WiFi y conéctese a la red Fireplace_WiFi_setup(si la red no está visible, desconecte el dispositivo FLA durante 10 segundos y repita la configuración). La aplicación buscará automáticamente la chimenea. Esto será confirmado por el mensaje SETUP NETWORK ACTIVE. Haga clic en CONNECT.</p>		<p>Connect to Home Network</p> <p>5. En la pantalla CONNECT TO HOME NETWORK, seleccione el (NETWORK NAME) que desea usar e ingrese su contraseña. Asegúrese de que la contraseña sea correcta y haga clic en (SUBMIT).</p>	
---	---	--	---





Your fireplaces		Access Point	
<p>6. En la siguiente pantalla YOUR FIREPLACES, seleccione el dispositivo que le interesa y haga clic en CONNECT. En esta pantalla, también puede personalizar el nombre de la chimenea haciendo clic en EDIT.</p>		<p>7. Si no desea utilizar ninguna de las redes disponibles, puede crear una red de ACCESS POINT dedicada y conectarse directamente al dispositivo. Para hacer esto, haga clic en (HELP), seleccione (CONNECTION TYPE) y luego (ACCESS POINT) confirmando haciendo clic en (CREATE ACCESS POINT). Ingrese el nombre de la red y la contraseña, confirme haciendo clic en NEXT.</p>	

Después de una configuración, el **LED WIFI** será verde



APLICACION FLA3 NET-ZERO

	<ol style="list-style-type: none"> 1. Newsletter 2. Modo chimenea 3. Nivel de combustible 4. Altura de la llama 5. Apagar y encender 6. Info 7. Menu
--	---

MENU

El menú está disponible después de hacer clic en el icono . Puede volver al panel principal después de hacer clic en **ATRÁS** . Para obtener información general sobre la chimenea, haga clic en el icono . Newsletter está disponible después de hacer clic en el icono .

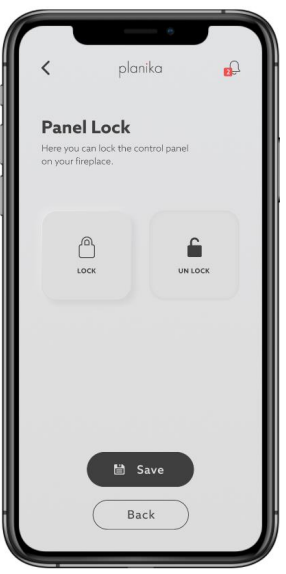

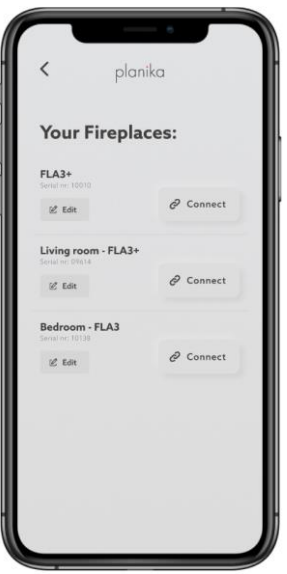
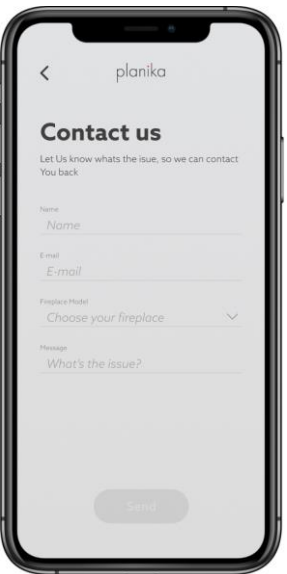











Menu	Info	Newsletter
		
<p>Configuración de la aplicación principal. Haga clic en la pestaña para cambiar la configuración.</p>	<p>Haga clic aquí para consultar la información básica sobre la chimenea.</p>	<p>Haga clic aquí para consultar las notificaciones.</p>

Panel Lock	Default Level	Your fireplaces	Contact Us
			
<p>Haga clic en LOCK para bloquear el panel de control de la chimenea. Haga clic en UNLOCK para desbloquear el panel de control de la chimenea. Confirme su selección con el botón SAVE. El cambio solo es posible en el dispositivo apagado.</p>	<p>Establezca el nivel de llama en el que la chimenea comenzará a funcionar cuando la encienda. Haga clic en SAVE para guardar los cambios. RESET para restablecer la configuración. La llama viene ajustada de fábrica al nivel 4.</p>	<p>Consulte las chimeneas disponibles. Haga clic en EDIT para editar el nombre del dispositivo. Haga clic en CONNECT para conectarse al dispositivo.</p>	<p>Póngase en contacto con Planika por correo electrónico. Haga clic en SEND para enviar el mensaje.</p>

MENSAJES DE ALARMA

Help	Error	File a Report
		
<p>Haga clic en HELP en el MENU principal para ir a la pestaña Troubleshooting.</p>	<p>Toma la acción por la falla. Si el error persiste, informe el problema haciendo clic en REPORT.</p>	<p>Si aún necesita ayuda del servicio, envíe un mensaje con una descripción de la falla e información básica haciendo clic en SEND.</p>

SEÑALES DE INFORMACIÓN

DIODO DE POTENCIA	DIODO DE ARRANQUE/PARADA	SONIDO	ACCIÓN	COMUNICACIÓN
		-	Flash verde	Dispositivo apagado
		-	Verde intermitente	El dispositivo está listo para funcionar
		-	Verde parpadeante	Procedimiento de arranque
		-	Funcionando	Funcionando
		-	Parpadeo azul	No hay combustible - Repostar
		-	Azul parpadeante	Repostar
			Azul parpadeante con sonido	Depósito lleno
			Parpadeo rojo con sonido	Extinguir, enfriar
			Púrpura parpadeante con sonido	Error - compruebe la aplicación (solución de problemas) y contacte con el servicio técnico
		-	Azul, rojo intermitente	El depósito de combustible está vacío
DIODO WI-FI			ACCIÓN	COMUNICACIÓN
			Parpadeo azul	No está conectado a wi-fi
			Azul parpadeante	Emparejamiento / configuración
			Parpadeo verde	Wi-fi conectado

COMBUSTIBLE - Use solo combustible de etanol producido a partir de plantas en el proceso de destilación de alcohol dos veces que consta de 95-96,6% de etanol por volumen. Fanola es el combustible recomendado con pureza farmacológica.

¡NO USE COMBUSTIBLES SINTÉTICOS A BASE DE PETRÓLEO YA QUE ESTÁN CONTAMINADOS, EMITEN OLORES DESAGRADABLES Y PUEDEN DAÑAR LA CHIMENEA! ¡NO UTILICE COMBUSTIBLES QUE CONTENGAN 100 % DE ETANOL POR VOLUMEN, GEL O COMBUSTIBLES AROMÁTICOS!

LIMPIEZA - Limpie con un paño húmedo y un detergente suave cuando el aparato esté apagado y enfriado.

SERVICIO - conserve el cable USB incluido para realizar el servicio. Correo electrónico de contacto service@planikafires.com

RAVITAILLEMENT DU CARBURANT

1. Ouvrez le volet (I) et allumez l'appareil en appuyant sur .
2. Si le réservoir est vide (**BOUTON START / STOP BLEU**) ou si vous souhaitez ajouter du carburant, connectez le tuyau de la pompe 'a' (vous entendrez un clic) et le cordon d'alimentation 'b' (II) (**LED BLEUE CLIGNOTANTE**).

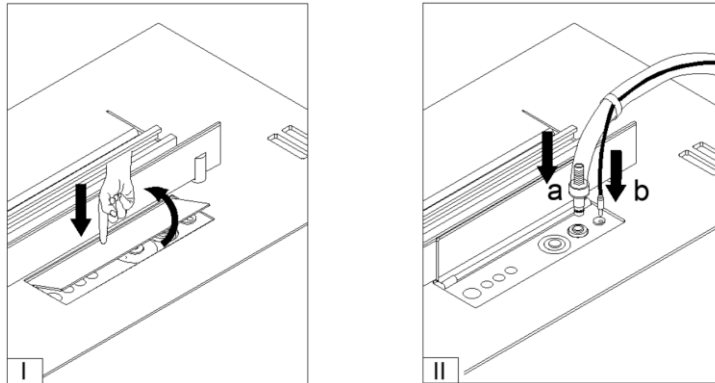

3. Si la bouteille de carburant est fixée avec le restricteur (bouchon sur le col des bouteilles) (III), retirez-le avant d'insérer l'entrée de la pompe à carburant (IV). Placer le bidon avec le carburant sur le sol et y placer le tuyau de la pompe 'c' (IV). Appuyez et maintenez enfoncé le bouton de la pompe (IV) pour commencer la distribution.

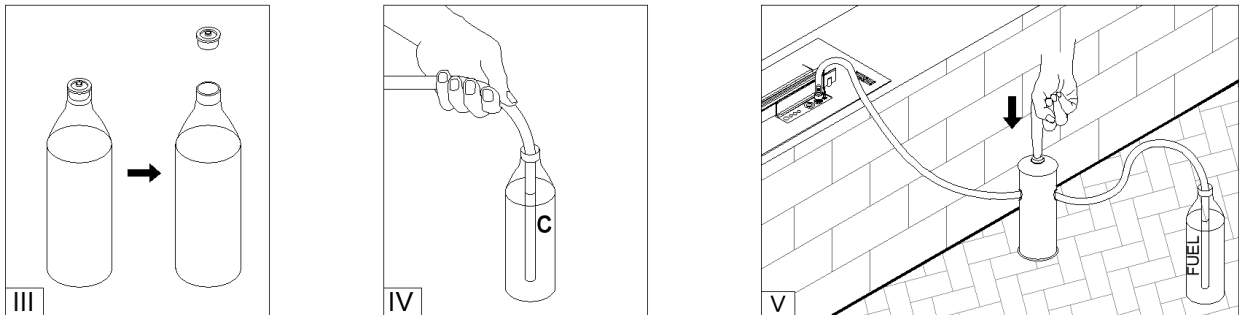

Lorsque le bidon de carburant est vide, remplacez-le par un bidon plein et redémarrez la pompe (voir point 3). La pompe s'arrête lorsque le réservoir de carburant est plein (signal acoustique).

4. Débranchez le cordon d'alimentation « b ». Pour déconnecter la pompe, tenez l'extrémité du tuyau et appuyez sur le bouton à l'endroit marqué d'un autocollant (VI).
5. Secouez le carburant restant du tuyau « c » dans la bouteille et placez la pompe dans le couvercle (VII).

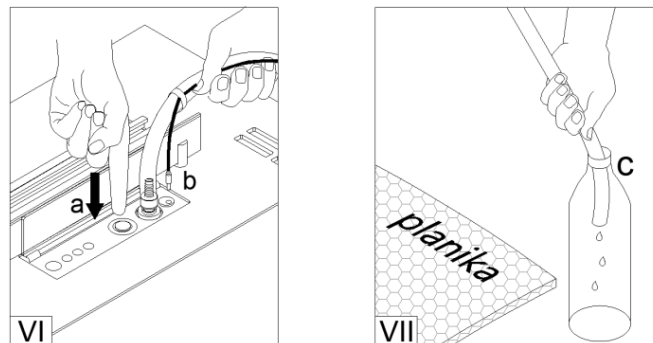



ALLUMAGE DE LA FLAMME

Le bouton **START / STOP** allumé en vert signifie que l'appareil est prêt à allumer la flamme.

Appuyez sur **Start**. Il faut 2 à 10 minutes pour allumer la flamme (**LED VERTE CLIGNOTANTE**). Pendant ce temps, vous pouvez sentir les vapeurs de carburant. Les diodes d'extinction signalent que la flamme s'est allumée et que l'appareil a atteint sa température de fonctionnement.

RÉGLAGE DE LA HAUTEUR DE FLAMME

Pendant que la flamme brûle, appuyez sur  ou  sur la télécommande ou déplacer la barre de hauteur de la flamme dans l'application pour augmenter ou diminuer sa hauteur sur 6 niveaux. La flamme se déclenche à la 4ème altitude. **ATTENTION!** En cas de température trop élevée de l'appareil, la hauteur de la flamme sera automatiquement réduite et son réglage est bloqué. Si la température continue d'augmenter, la flamme s'éteindra (**LED ROUGE**).

ÉTEINDRE LA FLAMME

Pour éteindre la flamme :

- appuyez sur **STOP**. Dans ce cas, les ventilateurs s'allumeront en plus pour accélérer le refroidissement de l'appareil. **La LED rouge clignotante** signifie que l'appareil refroidit. Le rallumage de la flamme n'est possible qu'après refroidissement de l'appareil (**LED VERTE**).



ÉTEINDRE LE DISPOSITIF

Pour éteindre complètement l'appareil, appuyez sur .

L'appareil s'éteindra automatiquement en cas de détection de dysfonctionnements (vérifiez l'erreur dans l'application).

CONFIGURATION DE COMMUNICATION SANS FIL

L'appareil est associé à l'application comme suit (un seul appareil peut être associé à la fois) :

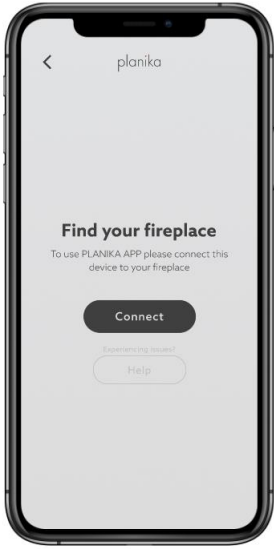
<p>Join the newsletter</p> <p>1. Lancez les FLA3 NET-ZERO applications sur le téléphone. Confirmez votre volonté de vous inscrire à la newsletter en entrant votre adresse e-mail et en cliquant sur SIGN UP ou passez l'étape en cliquant sur SKIP</p> <p>Google play Appstore</p>  		<p>Find your fireplace</p> <p>2. Sur l'écran FIND YOUR FIREPLACE, cliquez sur CONNECT pour lancer la recherche d'un réseau</p>	
--	--	---	--

3. Appuyez et maintenez enfoncé le bouton **WIFI**  sur la cheminée. Le clignotement du bouton signifie que le foyer est prêt pour la configuration. La mise en veille sera annulée après 5 minutes en cas d'inactivité.

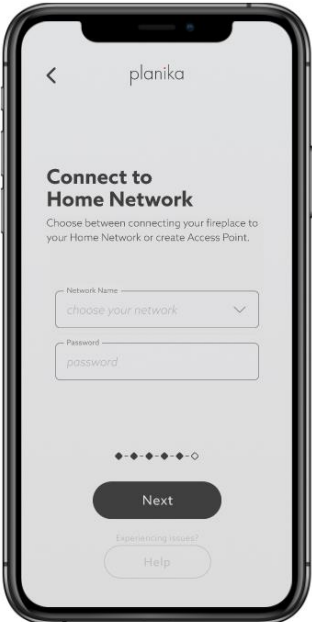

<p>Setup Network Active</p> <p>4. Accédez aux paramètres de l'appareil mobile, activez le réseau WiFi et connectez-vous au réseau Fireplace_WiFi_setup (si le réseau n'est pas visible, déconnectez l'appareil FLA pendant 10 secondes et répétez la configuration). La cheminée sera automatiquement recherchée par l'application. Ceci sera confirmé par le message SETUP NETWORK ACTIVE. Cliquez sur CONNECT.</p>		<p>Connect to Home Network</p> <p>5. Sur l'écran CONNECT TO HOME NETWORK, sélectionnez le (NETWORK NAME) que vous souhaitez utiliser et entrez son mot de passe. Assurez-vous que le mot de passe est correct et cliquez sur (SUBMIT).</p>	
--	---	--	---



Your fireplaces		Access Point	
<p>6. Sur l'écran suivant YOUR FIREPLACES, sélectionnez l'appareil qui vous intéresse et cliquez sur CONNECT. Sur cet écran, vous pouvez également personnaliser le nom du foyer en cliquant sur EDIT.</p>		<p>7. Si vous ne souhaitez utiliser aucun des réseaux disponibles, vous pouvez créer un réseau ACCESS POINT dédié et vous connecter directement à l'appareil. Pour cela, cliquez sur (HELP), sélectionnez (CONNECTION TYPE) puis (ACCESS POINT) validez en cliquant sur (CREATE ACCESS POINT). Entrez le nom du réseau et le mot de passe, confirmez en cliquant sur NEXT.</p>	



Après une configuration réussie, la LED WIFI sera verte

APPLICATION FLA3 NET-ZERO





	<ol style="list-style-type: none"> 1. Newsletter 2. Mode cheminée 3. Niveau de carburant 4. Hauteur de la flamme 5. Éteindre et allumer 6. Informations 7. Menu
---	--

MENU

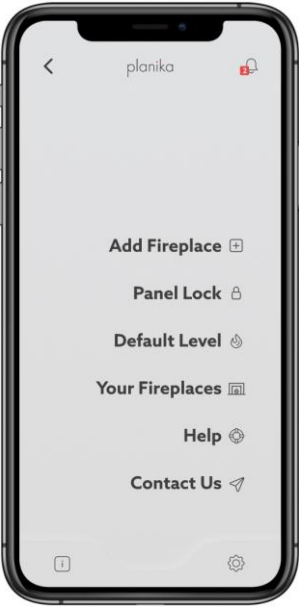
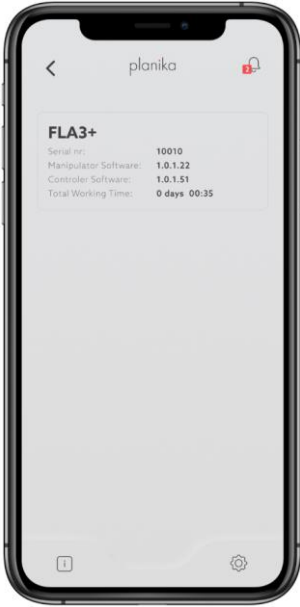
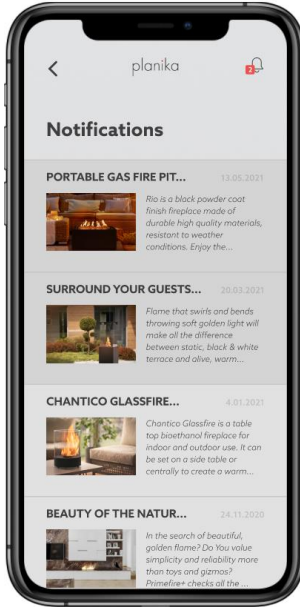

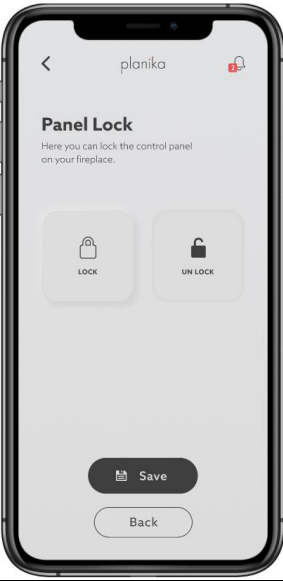
Le menu est accessible après avoir cliqué sur l'icône . Vous pouvez revenir au panneau principal après avoir cliqué sur **RETOUR** 

Pour obtenir des informations générales sur la cheminée, cliquez sur l'icône . La newsletter est disponible après avoir cliqué sur l'icône 





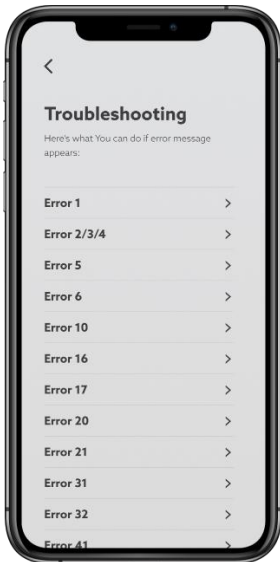

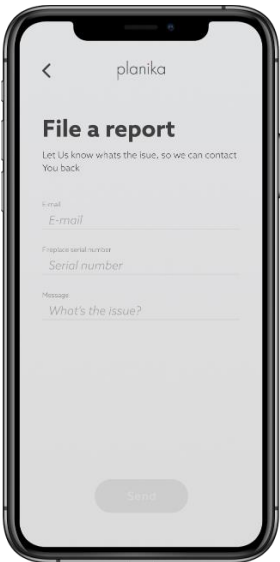







Menu	Info	Newsletter
		
<p>Paramètres principaux de l'application. Cliquez sur l'onglet pour modifier les paramètres.</p>	<p>Cliquez ici pour vérifier les informations de base sur la cheminée.</p>	<p>Cliquez ici pour vérifier les notifications.</p>

Panel Lock	Default Level	Your fireplaces	Contact Us
			
<p>Cliquez sur LOCK pour verrouiller le panneau de commande du foyer. Cliquez sur UNLOCK pour déverrouiller le panneau de commande du foyer. Confirmez votre sélection avec le bouton SAVE</p>	<p>Réglez le niveau de flamme auquel le foyer commencera à fonctionner lorsque vous l'allumerez. Cliquez sur SAVE pour enregistrer les modifications. RESET pour réinitialiser les paramètres. La flamme est réglée en usine au niveau 4.</p>	<p>Vérifiez les cheminées disponibles. Cliquez sur EDIT pour modifier le nom de l'appareil. Cliquez sur CONNECT pour vous connecter à l'appareil.</p>	<p>Contactez Planika par e-mail. Cliquez sur SEND pour envoyer le message.</p>

MESSAGES D'ALARME

Help	Error	File a Report
		
<p>Cliquez sur HELP dans le MENU principal pour accéder à l'onglet Troubleshooting.</p>	<p>Prendre l'action pour la faute. Si l'erreur persiste, veuillez signaler le problème en cliquant sur REPORT.</p>	<p>Si vous avez encore besoin de l'aide du service, envoyez un message avec une description de la panne et des informations de base en cliquant sur SEND.</p>

SIGNAUX D'INFORMATION

DIODE D'ALIMENTATION	DIODE MARCHE/ARRÊT	SON	ACTION	COMMUNICATION
		-	L'éclair vert	L'appareil est éteint
		-	Flash vert	L'appareil est prêt à fonctionner
		-	Clignotement vert	Procédure de démarrage
		-		Fonctionnement
		-	Bleu clignotant	Pas de carburant - Ravitaillement
		-	Clignotement bleu	Ravitaillement en carburant
			Clignotement bleu avec son	Réservoir plein
			Rouge clignotant avec son	Vidange, refroidissement
			Flash violet avec son	Erreur - vérifier l'application (dépannage) et contacter le service après-vente.
		-	Bleu, rouge clignotant	Le réservoir de carburant est vide
DIODE WI-FI			ACTION	COMMUNICATION
			Bleu clignotant	Non connecté au wi-fi
			Bleu clignotant	Jumelage / configuration
			Vert clignotant	Wi-fi connecté

CARBURANT - Utilisez uniquement du carburant à l'éthanol produit à partir de plantes dans le processus de distillation d'alcool en deux temps composé de 95 à 96,6% d'éthanol en volume. Fanola est le carburant recommandé avec une pureté pharmacologique.

N'UTILISEZ PAS DE COMBUSTIBLES À BASE DE PÉTROLE SYNTHÉTIQUE CAR ILS SONT CONTAMINÉS, ÉMETTENT DES ODEURS DÉSAGRÉABLES ET PEUVENT ENDOMMAGER LE FOYER ! N'UTILISEZ PAS DE CARBURANTS CONTENANT 100 % D'ÉTHANOL EN VOLUME, DE GEL OU DE CARBURANTS AROMATIQUES !

NETTOYAGE - Nettoyer avec un chiffon humide et un détergent doux lorsque l'appareil est éteint et refroidi.

SERVICE - Conservez le câble USB fourni pour le service. Contactez par e-mail service@planikafires.com

RIFORMIMENTO DI COMBUSTIBILE

1. Aprire lo sportello (I) e accendere il dispositivo premendo .
2. Se il serbatoio è vuoto (**PULSANTE AVVIO/ARRESTO si illuminerà in blu**) o si desidera aggiungere del combustibile, collegare il tubo della pompa 'a' con un movimento deciso (si sentirà un clic) e il cavo di alimentazione 'b' (II) (**LED BLU LAMPEGGIANTE**).

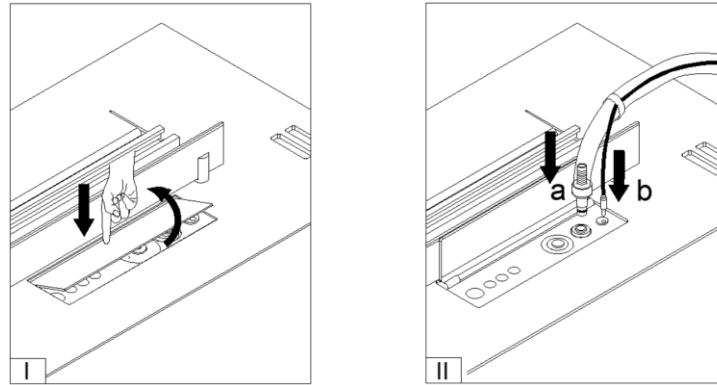

3. Se la bottiglia del combustibile contiene il tappo interno (il tappo sul collo della bottiglia) (III), bisogna rimuoverlo prima di inserire il bocchettone della pompa del combustibile (IV). Posizionare in modo stabile il contenitore di combustibile sul pavimento e inserire il tubo della pompa 'c' (IV) al suo interno. Per iniziare il rifornimento tenere premuto il pulsante sulla pompa (V).

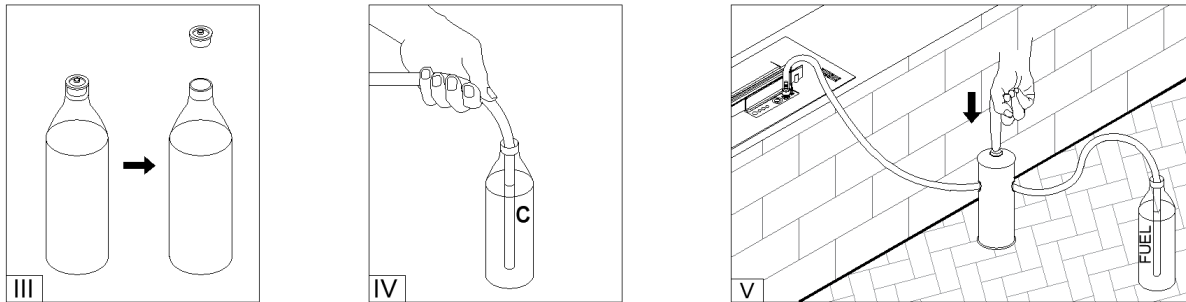

Quando il serbatoio del combustibile è vuoto, sostituirlo con uno pieno e riavviare la pompa (vedi sezione 3). La pompa si spegne quando il serbatoio del carburante è pieno (segnale acustico).

4. Scollegare il cavo di alimentazione "b". Per scollegare la pompa, afferrare l'estremità del tubo e premere con decisione il pulsante nel punto contrassegnato da un adesivo (VI).
5. Scuotere il carburante rimanente dal tubo 'c' sul coperchio della pompa (VII).

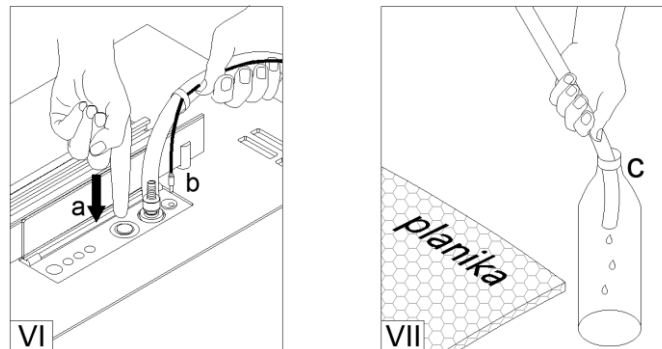



ACCENSIONE DELLA FIAMMA

Il pulsante **START/STOP** illuminato in verde indica che il dispositivo è pronto per l'accensione della fiamma.

Premere **START**. Occorrono 2-10 minuti per accendere la fiamma (**LED VERDE LAMPEGGIANTE**). Durante questo periodo, è possibile sentire l'odore dei vapori del combustibile. I LED spenti informano che la fiamma è stata accesa e il dispositivo ha raggiunto la sua temperatura di esercizio.

REGOLAZIONE DELL'ALTEZZA DELLA FIAMMA

Mentre la fiamma è accesa, premere  o  sul telecomando o spostare la barra dell'altezza della fiamma nell'applicazione per aumentare o diminuire la sua altezza (6 livelli disponibili). La fiamma si accende come impostazione di fabbrica sul 4 livello.

ATTENZIONE! In caso di temperatura troppo elevata del dispositivo, l'altezza della fiamma verrà automaticamente ridotta e la sua regolazione sarà bloccata. Se la temperatura continua ad aumentare la fiamma si spegne (**LED ROSSO**)

SPEGNIMENTO DELLA FIAMMA

Per spegnere la fiamma:

- premere **STOP**. In questo caso, le ventole si accenderanno per accelerare il raffreddamento del dispositivo.

LED rosso lampeggiante indica che il dispositivo si sta raffreddando. La riaccensione della fiamma è possibile solo dopo che il dispositivo si è raffreddato (**LED VERDE**).



SPEGNIMENTO DEL DISPOSITIVO

Per spegnere completamente il dispositivo, premere .

Il dispositivo si spegnerà automaticamente in caso di irregolarità nel suo funzionamento (verificare l'errore nell'applicazione).

CONFIGURAZIONE WIRELESS

Il dispositivo viene configurato con l'applicazione come descritto in seguito (è possibile configurare un solo dispositivo alla volta):

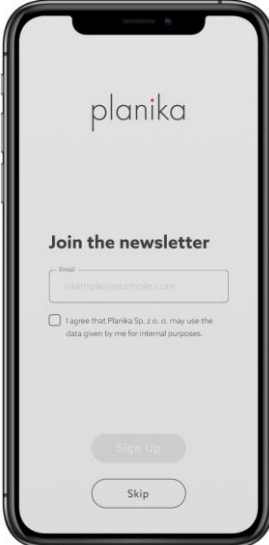
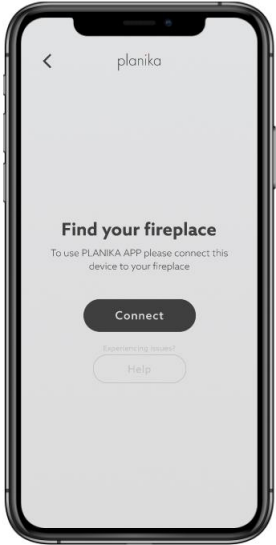
<p>Join the newsletter</p> <p>1. Avviare FLA3 NET-ZERO l'applicazione sul telefono. Confermare la volontà di iscriversi alla newsletter inserendo l'indirizzo e-mail e cliccando SIGN UP oppure saltare la fase cliccando SKIP</p> <p>Google play Appstore</p>  		<p>Find your fireplace</p> <p>2. Nella schermata FIND YOUR FIREPLACE fare clic su CONNECT per avviare la ricerca di una rete</p>	
---	--	---	--

3. Tenere premuto il pulsante **WIFI**  sul camino. Il lampeggio del pulsante indica che il caminetto è pronto per la configurazione. In caso di inattività, lo standby verrà annullato dopo 5 minuti.

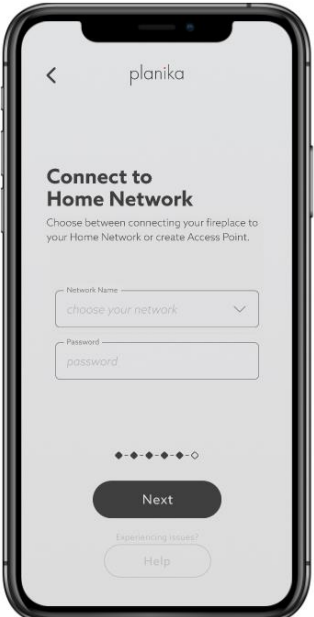

<p>Setup Network Active</p> <p>4. Passare alle impostazioni del dispositivo mobile, accendere la rete WiFi e connettersi alla rete Fireplace_WiFi_setup(se la rete non è visibile, disconnettere il dispositivo FLA per 10 secondi e ripetere la configurazione). Il caminetto verrà ricercato automaticamente dall'applicazione. Come conferma apparirà il messaggio SETUP NETWORK ACTIVE Fare clic su CONNECT.</p>		<p>Connect to Home Network</p> <p>5. Sullo schermo CONNECT TO HOME NETWORK selezionare il nome della rete che si desidera utilizzare (NETWORK NAME) e inserire la password. Assicurarsi che la password sia corretta e fare clic su (SUBMIT).</p>	
--	---	---	---



Your fireplaces		Access Point	
<p>6. Nella schermata successiva YOUR FIREPLACES, selezionare il dispositivo e cliccare CONNECT. In questa schermata è possibile personalizzare il nome del caminetto cliccando EDIT.</p>		<p>7. Se non si desidera utilizzare nessuna delle reti disponibili, è possibile creare una rete ACCESS POINT dedicata e connettersi direttamente al dispositivo. Per fare ciò, fare clic su (HELP), selezionare (CONNECTION TYPE e poi (ACCESS POINT)) confermare cliccando su (CREATE ACCESS POINT). Immettere il nome della rete e la password, confermare facendo clic su NEXT</p>	

Al termine della configurazione, il LED WIFI si illuminerà in verde

APPLICAZIONE FLA3 NET-ZERO



	<ol style="list-style-type: none"> 1. Newsletter 2. Modalità camino 3. Livello combu 4. L'altezza della fiamma 5. Spegner e accendere 6. Info 7. Menu
---	--

MENU

Il menu è disponibile dopo aver cliccato sull'icona . Per tornare al pannello principale fare clic su **INDIETRO** 

Per informazioni generali sul camino, fare clic sull'icona . Newsletter è disponibile dopo aver cliccato sull'icona 

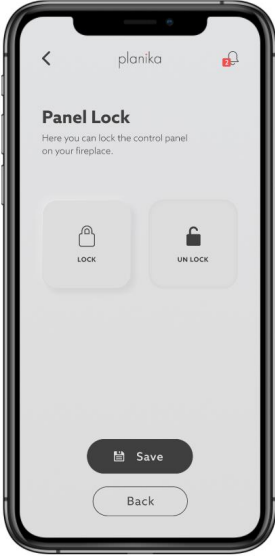

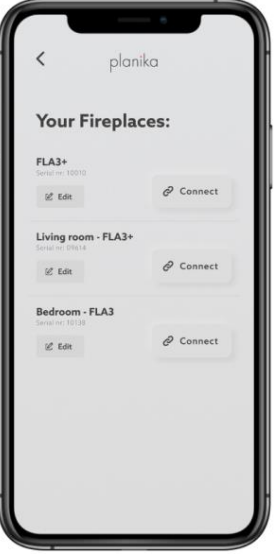
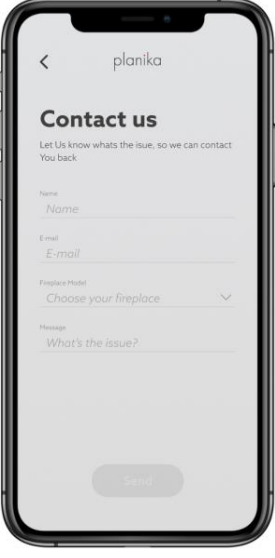

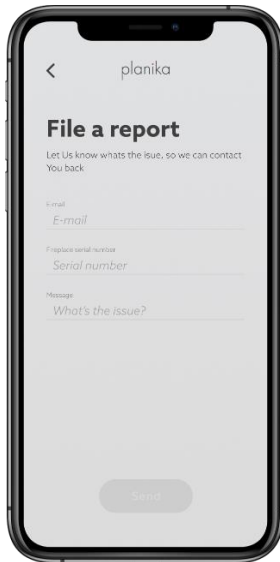

Menu	Info	Newsletter
		
<p>Impostazioni principali dell'applicazione. Fare clic sulla scheda per modificare le impostazioni.</p>	<p>Clicca qui per controllare le informazioni di base sul camino.</p>	<p>Clicca qui per controllare le notifiche.</p>

Panel Lock	Default Level	Your fireplaces	Contact Us
			
<p>Fare clic su LOCK per bloccare il pannello di controllo sul caminetto. Fare clic su UNLOCK per sbloccare il pannello di controllo sul caminetto.. Confermare la selezione con il pulsante SAVE. La modifica è possibile solo a dispositivo spento.</p>	<p>Impostare il livello di fiamma al quale il caminetto dovrà iniziare a funzionare. Fare clic su SAVE per salvare le modifiche. RESET per ripristinare le impostazioni. L'impostazione di fabbrica della fiamma è al livello</p>	<p>Controlla i caminetti disponibili. Fare clic su EDIT per modificare il nome del dispositivo. Fare clic su CONNECT per connettersi al dispositivo.</p>	<p>Contattare Planika via e-mail. Fare clic su SEND er inviare il messaggio.</p>

MESSAGGI DI ALLARME

Help	Error	File a Report
		
<p>Fare clic su HELP nel MENU principale per andare alla scheda Risoluzione dei problemi</p>	<p>Intraprendere l'azione per eliminare il guasto. Se l'errore persiste, segnala il problema facendo clic su REPORT.</p>	<p>Se hai ancora bisogno di aiuto dal servizio, invia un messaggio con una descrizione del guasto e le informazioni di base facendo clic su SEND.</p>

SEGNALI INFORMATIVI

DIODO DI ALIMENTAZIONE	DIODO DI AVVIO/ARRESTO	SUONO	AZIONE	COMUNICAZIONE
		-	Lampo verde	Dispositivo spento
		-	Verde lampeggiante	Il dispositivo è pronto a funzionare
		-	Verde lampeggiante	Procedura di avvio
		-		Funzionamento
		-	Lampeggiante blu	Assenza di carburante - Rifornimento
		-	Lampeggiante blu	Rifornimento
			Lampeggio blu con suono	Serbatoio pieno
			Lampo rosso con suono	Estrazione, raffreddamento
			Lampo viola con suono	Errore - controllare l'applicazione (risoluzione dei problemi) e contattare l'assistenza.
		-	Blu, rosso lampeggiante	Il serbatoio del carburante è vuoto
DIODO WI-FI		AZIONE		COMUNICAZIONE
			Lampeggio blu	Non connesso al wi-fi
			Blu lampeggiante	Accoppiamento / configurazione
			Verde lampeggiante	Wi-fi connesso

COMBUSTIBILE - Utilizzare solo il combustibile a base di etanolo prodotto dalle piante nel processo di distillazione dell'alcool a due tempi che consiste nel 95-96,6% di etanolo in volume. Fanola è il combustibile raccomandato con purezza farmaceutica.

NON USARE COMBUSTIBILI SINTETICI A BASE DI PETROLIO PERCHÉ SONO CONTAMINATI, EMETTONO ODORI SGRADUEVOLI E POSSONO DANNEGGIARE IL CAMINETTO! NON UTILIZZARE COMBUSTIBILI CONTENENTI IL 100%, GEL O COMBUSTIBILI AROMATICI!

PULIZIA – Pulire con un panno umido e detergenti delicati quando il dispositivo è spento e freddo.

SERVIS – Conservare il cavo USB incluso per la manutenzione. Contatto e-mail service@planikafires.com

UZUPEŁNIANIE PALIWA

1. Otwórz klapkę (I) i włącz urządzenie, wciskając .
2. Jeżeli zbiornik jest pusty (**PRZYCIŚK START/STOP PODŚWIETLONY NA NIEBIESKO**) lub chcesz dolać paliwa, pewnym ruchem podłącz wąż pompy 'a' (usłyszysz klik) oraz przewód zasilający 'b' (II) (**NIEBIESKA DIODA MRUGA**).

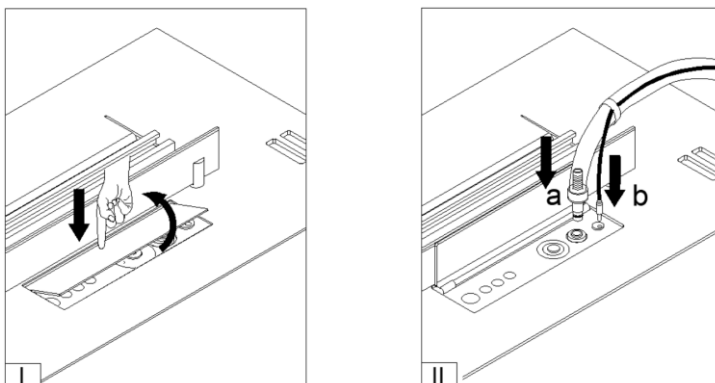

3. Jeżeli pojemnik z paliwem jest zabezpieczony ogranicznikiem (nakrętka na szyjce butelki) (III) należy ją zdjąć przed włożeniem wlewu pompki paliwowej (IV). Pojemnik z paliwem ustaw stabilnie na podłodze i umieść w nim przewód pompy 'c' (IV). Wciśnij i przytrzymaj przycisk na pompie (V), aby rozpocząć nalewanie.

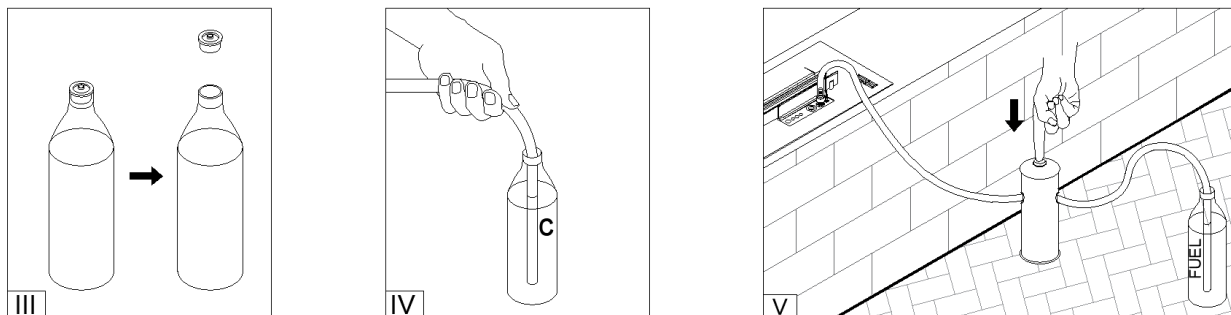

Gdy pojemnik z paliwem zostanie opróżniony, wymień go na pełny i uruchom pompę ponownie (patrz pkt. 3).

Pompa wyłączy się, gdy zbiornik paliwa zostanie zapełniony (sygnał dźwiękowy).

4. Odłącz przewód zasilający 'b'. Aby wypiąć pompę, przytrzymaj koniec węża 'a' i mocno naciśnij przycisk w miejscu oznaczonym naklejką (VI).
5. Strząśnij resztkę paliwa z przewodu 'c' do butelki i umieść pompę w pokrowcu (VII).

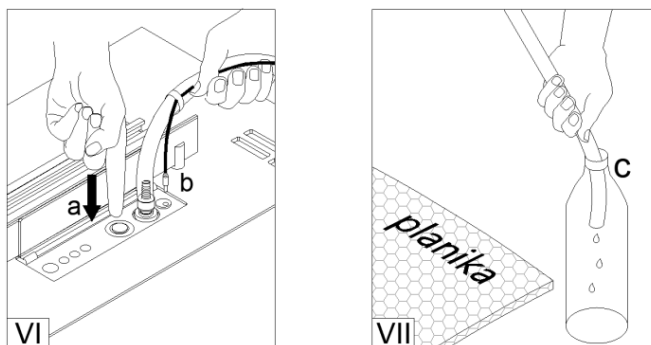



ODPALANIE PŁOMIENIA

Przycisk **START / STOP** podświetlony na zielono oznacza, że urządzenie jest gotowe do odpalenia płomienia.

Wciśnij **START**. Odpalenie płomienia trwa 2-10 minut (**MRUGAJĄCA ZIELONA DIODA**). W tym czasie może być wyczuwalny zapach oparów paliwa. Gasnące diody informują, że płomień został odpalony i urządzenie osiągnęło temperaturę roboczą.

REGULACJA WYSOKOŚCI PŁOMIENIA

Gdy płomień jest odpalony, wciśnij  lub  na pilocie lub przesuwaj pasek wysokości płomienia w aplikacji, aby zwiększyć lub zmniejszyć jego wysokość w 6 poziomach. Płomień domyślnie odpala się na 4. poziomie wysokości.

UWAGA! W przypadku zbyt wysokiej temperatury urządzenia, wysokość płomienia zostanie automatycznie zmniejszona, a możliwość jej regulacji zablokowana. Jeżeli temperatura będzie nadal wzrastać, płomień zostanie wygaszony (**CZERWONA DIODA**).

WYGASZANIE PŁOMIENIA

Aby wygasić płomień:

- wciśnij **STOP**. W tym przypadku dodatkowo włączą się wentylatory, przyspieszające schładzanie urządzenia.

Mrugająca czerwona dioda oznacza, że urządzenie jest schładzane. Ponowne odpalenie płomienia możliwe jest dopiero po wychłodzeniu urządzenia (**ZIELONA DIODA**).

WYŁĄCZANIE URZĄDZENIA

Aby całkowicie wyłączyć urządzenie wciśnij .

Urządzenie wyłączy się automatycznie w przypadku wykrycia nieprawidłowości w pracy (sprawdź błąd w aplikacji).

KONFIGURACJA ŁĄCZNOŚCI BEZPRZEWODOWEJ

Parowanie urządzenia z aplikacją odbywa się następująco (jednocześnie można parować tylko jedno urządzenie):

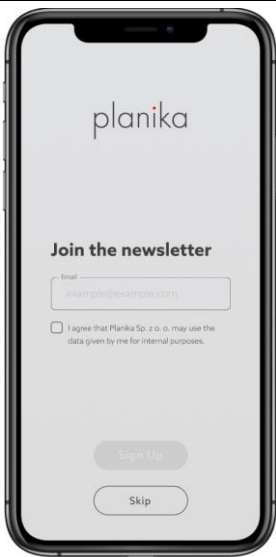
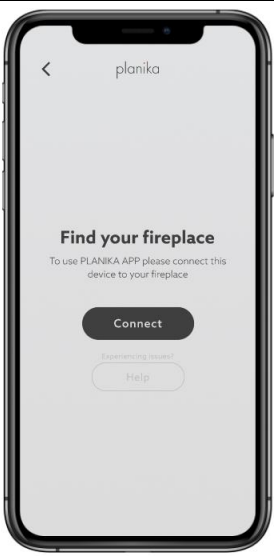
<p>Join the newsletter</p> <p>1. Włącz aplikację FLA3 NET-ZERO na telefonie. Potwierdź chęć przystąpienia do newslettera wpisując adres e-mail i klikając SIGN UP lub pomiń etap klikając SKIP</p> <p>Google play Appstore</p> 		<p>Find your fireplace</p> <p>2. Na ekranie FIND YOUR FIREPLACE kliknij CONNECT aby rozpocząć wyszukiwanie sieci</p>	
--	--	---	--

3. Wciśnij i przytrzymaj przycisk **WIFI**  na kominku. Mruganie przycisku oznacza gotowość kominka do parowania. W przypadku braku aktywności gotowość zostanie anulowana po 5 minutach.

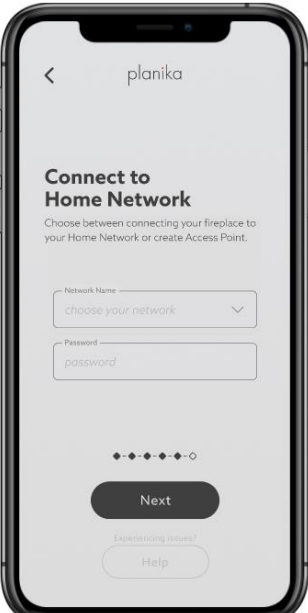

<p>Setup Network Active</p> <p>4. Przejdź do ustawień urządzenia mobilnego, włącz sieć WiFi i połącz się z siecią Fireplace_WiFi_setup (jeżeli sieć nie jest widoczna, odłącz zasilanie urządzenia FLA na 10 sekund i powtórz konfigurację). Kominek zostanie automatycznie wyszukany przez aplikację. Potwierdzi to komunikat SETUP NETWORK ACTIVE. Kliknij CONNECT.</p>		<p>Connect to Home Network</p> <p>5. Na ekranie CONNECT TO HOME NETWORK wybierz nazwę sieci, którą chcesz docelowo używać (NETWORK NAME) oraz wprowadź jej hasło. Upewnij się, że hasło jest prawidłowe i kliknij (SUBMIT).</p>	
---	---	---	---



Your fireplaces		Access Point	
<p>6. Na następnym ekranie YOUR FIREPLACES, wybierz interesujące Cię urządzenie i kliknij CONNECT. Na tym ekranie dostosujesz też nazwę kominka klikając EDIT.</p>		<p>7. Jeżeli nie chcesz używać żadnej z dostępnych sieci, możesz stworzyć dedykowaną sieć ACCESS POINT i łączyć się z urządzeniem bezpośrednio. Aby to zrobić kliknij (HELP), wybierz (CONNECTION TYPE) a następnie (ACCESS POINT) zatwierdzając kliknięciem w (CREATE ACCESS POINT). Wprowadź nazwę sieci oraz hasło, potwierdź klikając NEXT</p>	

Po udanej konfiguracji dioda WIFI będzie świecić się na zielono



APLIKACJA FLA3 NET-ZERO



	<ol style="list-style-type: none"> 1. Newsletter 2. Tryb kominka 3. Poziom paliwa 4. Wysokość płomienia 5. Wygaszenie i odpalenie 6. Info 7. Menu
---	--

MENU

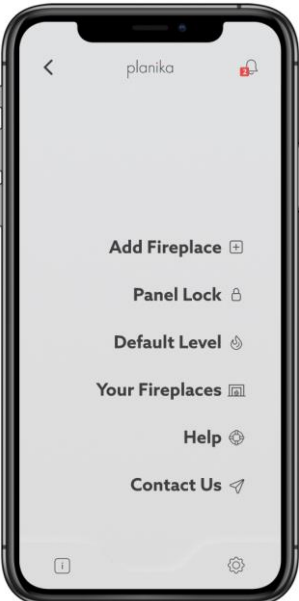

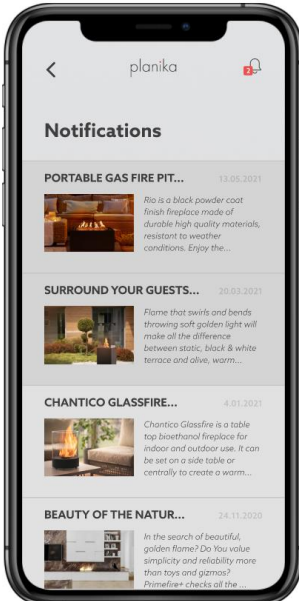
Menu jest dostępne po kliknięciu w ikonę . Powrót do głównego panelu jest możliwy po kliknięciu **WSTECZ** 

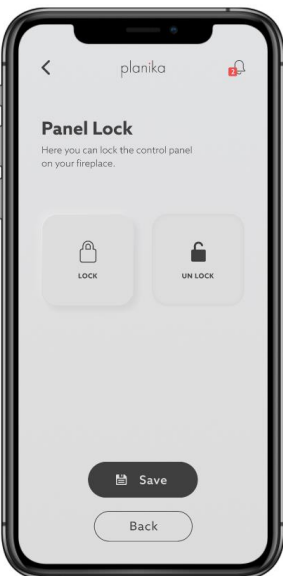
W celu uzyskania informacji ogólnych o kominku kliknij ikonę . Newsletter dostępny jest po kliknięciu w ikonę 

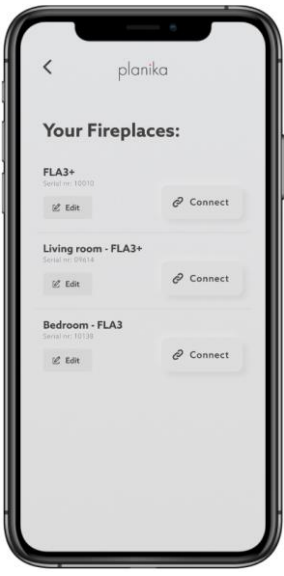
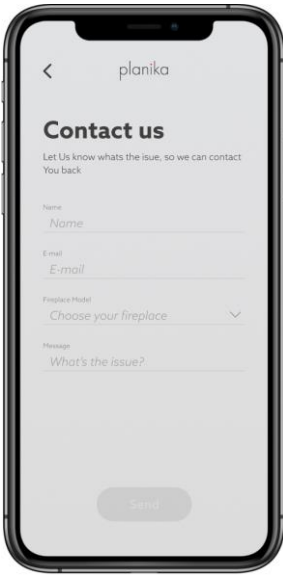



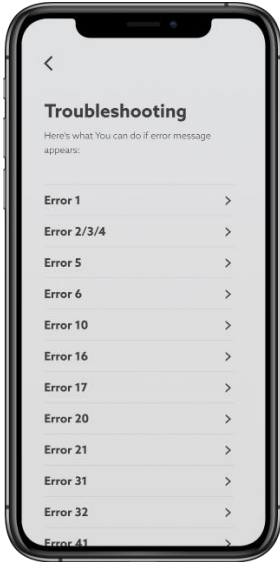

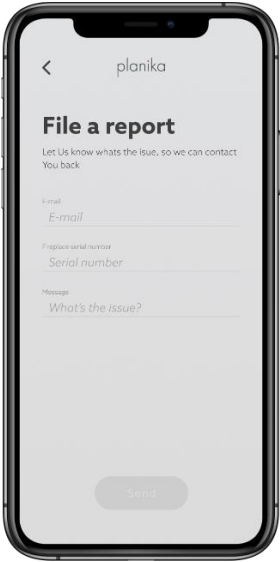





Menu	Info	Newsletter
		
<p>Główne ustawienia aplikacji. Kliknij w zakładkę w celu zmiany ustawień.</p>	<p>Kliknij aby sprawdzić podstawowe informacje o kominku.</p>	<p>Kliknij aby sprawdzić powiadomienia.</p>

Panel Lock	Default Level	Your fireplaces	Contact Us
			
<p>Kliknij LOCK aby zablokować panel sterowania na kominku. Kliknij UNLOCK aby odblokować panel sterowania na kominku. Wybór potwierdź przyciskiem SAVE. Zmiana jest możliwa tylko na zgaszonym urządzeniu.</p>	<p>Ustaw poziom płomienia, na którym kominek rozpocznie pracę po jego włączeniu. Kliknij SAVE aby zapisać zmiany. RESET aby zresetować ustawienia. Płomień fabrycznie jest ustawiony na poziomie 4.</p>	<p>Sprawdź dostępne kominki. Kliknij EDIT aby edytować nazwę urządzenia. Kliknij CONNECT w celu połączenia się z urządzeniem.</p>	<p>Skontaktuj się z Planiką poprzez wiadomość e-mail. Kliknij SEND aby wysłać wiadomość.</p>

KOMUNIKATY ALARMOWE

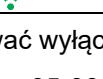
Help	Error	File a Report
		
<p>Kliknij HELP w głównym MENU aby przejść do zakładki Troubleshooting.</p>	<p>Wykonaj działanie dotyczące danej usterki. Jeśli error nadal się pojawia zgłoś sprawę klikając REPORT.</p>	<p>Jeśli nadal potrzebujesz pomocy serwisu, wyślij wiadomość z opisem usterki oraz podstawowymi informacjami klikając SEND.</p>

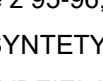
SYGNAŁY INFORMACYJNE

DIODA POWER	DIODA START/STOP	DŹWIEK	SYGNAŁ	KOMUNIKAT
		-	Zielony świeci	Urządzenie wyłączone
		-	Zielony świeci	Urządzenie gotowe do pracy
		-	Zielony mruga	Procedura odpalania
		-		Working
		-	Niebieski świeci	Brak paliwa- tankowanie
		-	Niebieski mruga	Tankowanie
			Niebieski mruga z dźwiękiem	Pełny zbiornik
			Czerwony świeci z dźwiękiem	Wygaszanie, chłodzenie
			Fioletowy świeci z dźwiękiem	Error – Sprawdź app (troubleshooting) I skontaktuj się z serwisem
		-	Niebieski i czerwony mruga	Zbiornik paliwa jest pusty
DIODA WI-FI		SYGNAŁ		KOMUNIKAT
				Nie podłączony do wi-fi
				Parowanie / konfigurowanie
				Wi-fi połączone

PALIWO - Należy stosować wyłącznie paliwa etanolowego, powstałego z roślin w procesie dwukrotnej destylacji alkoholu składającego się z 95-96,6% objętości etanolu. Zalecany paliwem o czystości farmakologicznej jest Fanola. **NIE NALEŻY UŻYWAĆ SYNTETYCZNYCH PALIW NA BAZIE ROPY NAFTOWEJ, PONIEWAŻ SĄ ONE ZANIECZYSZCZONE, WYDZIELAJĄ NIEPRZYJEMNE ZAPACHY I MOGĄ USZKODZIĆ KOMINEK! NIE NALEŻY UŻYWAĆ PALIW ZAWIERAJĄCYCH OBJĘTOŚCIOWO 100% ETANOLU, PALIWA ŻELOWEGO LUB AROMATYZOWANEGO!**

CZYSZCZENIE – Czyść wilgotną szmatką i delikatnymi środkami, gdy urządzenie jest wyłączone i chłodne.

SERWIS – Zachowaj dołączony przewód USB do celów serwisowych. Kontakt mailowy service@planikafires.com

НАПОЛНЕНИЕ УСТРОЙСТВА ТОПЛИВОМ

1. Откройте крышку (I) и включите прибор, нажав .
2. Если бак пуст (**КНОПКА START / STOP СВЕТИТСЯ СИНИМ ЦВЕТОМ**) или вы хотите добавить топливо, твердым движением подсоедините шланг насоса «а» (вы услышите щелчок) и шнур питания «b» (II) (**СИНИЙ СВЕТОДИОД МИГАЕТ**).

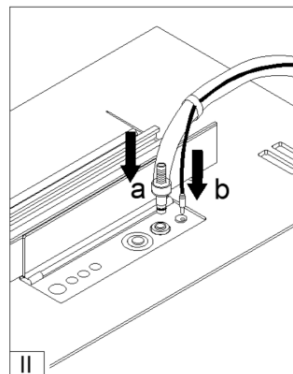
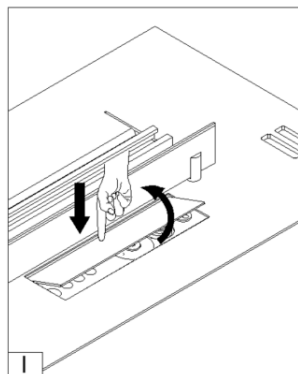

3. Если топливный баллон закреплен ограничителем (колпачком на горлышке баллона) (III), снимите его, прежде чем вставлять впускное отверстие топливного насоса (IV). Бак с топливом надо стабильно поставить на полу и поместить в него трубку автоматического насоса 'с' (IV). Нажать и удерживать кнопку на насосе (V), чтобы начался процесс наполнения топливом.

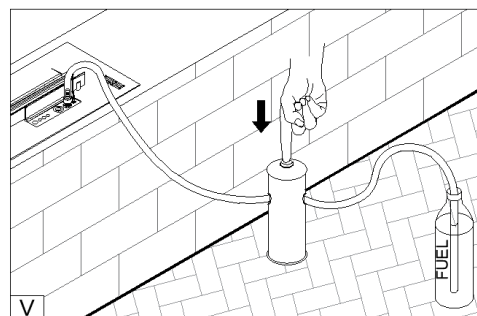
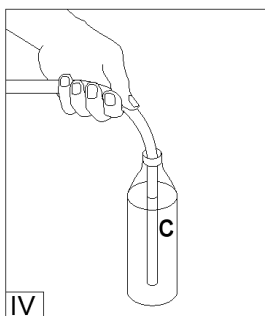
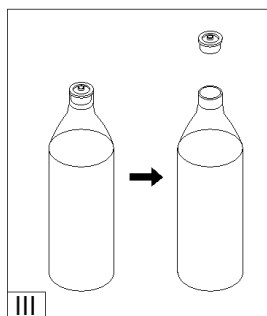

Когда ёмкость с топливом опустеет, замените её наполненной и перезапустите насос (см. Пункт 3). Насос выключится, когда топливный бак будет полон (звуковой сигнал).

4. Отсоедините шнур питания «b». Чтобы отсоединить насос, придерживая конец шланга, сильно нажмите кнопку в месте, отмеченном наклейкой (VI).
5. Вылейте остаток топлива из шланга «с» в ёмкость и поместите насос в чехол (VII).

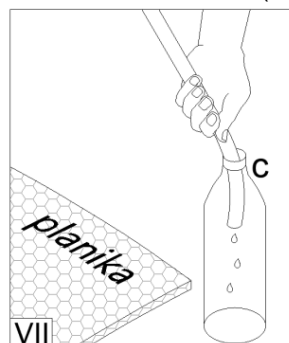
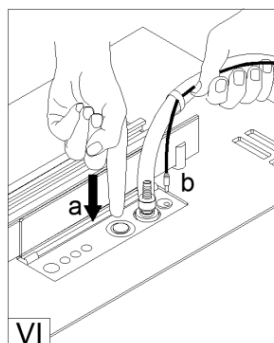



ЗАПУСК КАМИНА

Зеленая подсветка кнопки **START / STOP** означает, что устройство готово к розжигу пламени.

Нажмите **START**. Для розжига пламени потребуется около 2-10 минут (**МИГАЮЩИЙ ЗЕЛЕНЫЙ СВЕТОДИОД**). На протяжении этого времени вы можете почувствовать запах паров топлива. Угасающие светодиоды информируют о возгорании пламени и о достижении устройством рабочей температуры.

РЕГУЛИРОВАНИЕ РАЗМЕРА ПЛАМЕНИ

Когда пламя горит, нажмите  или  на пульте дистанционного управления либо переместить планку высоты пламени в приложении, чтобы увеличить или уменьшить его высоту на 6 уровней. По умолчанию пламя разгорается на 4-й высоте.

ВНИМАНИЕ! Если температура устройства слишком высокая, высота пламени будет автоматически уменьшена, и ее регулировка будет заблокирована. Если температура продолжит расти, пламя погаснет (**КРАСНЫЙ светодиод**).

ГАШЕНИЕ ПЛАМЕНИ

Чтобы погасить пламя:

нажмите **STOP**. В этом случае дополнительно включатся вентиляторы для ускорения охлаждения устройства.

Мигающий красный светодиод означает, что устройство остывает. Повторное зажигание пламени возможно только после того, как устройство остынет (ЗЕЛЕНЫЙ светодиод).

ВЫКЛЮЧЕНИЕ УСТРОЙСТВА

Чтобы полностью выключить устройство, нажмите кнопку .

Устройство автоматически выключится в случае сбоев в работе (проверьте ошибку в приложении.).

БЕСПРОВОДНАЯ КОНФИГУРАЦИЯ

Устройство сопрягается с приложением следующим образом (одновременно может быть сопряжено только одно устройство):

<p>Join the newsletter</p> <p>1. Запустите приложения FLA3 NET-ZERO в телефоне. Подтвердите свое желание подписаться на рассылку новостей, введя свой адрес электронной почты и нажав SIGN UP или пропустите шаг, нажав SKIP</p> <p>Google play Appstore</p>  		<p>Find your fireplace</p> <p>2. На экране FIND YOUR FIREPLACE нажмите CONNECT чтобы начать поиск сети.</p>	
---	--	--	--

3. Нажмите и удерживайте кнопку **WIFI**  на камине. Мигание кнопки означает, что камин готов к сопряжению. В случае бездействия режим ожидания будет отменен через 5 минут.

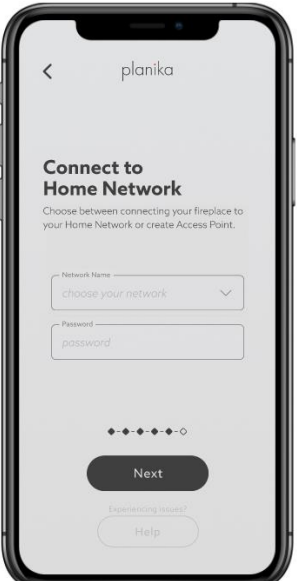

<p>Setup Network Active</p> <p>4. Зайдите в настройки мобильного устройства, включите сеть WiFi и подключитесь к сети Fireplace_WiFi_setup (если сеть не видна, отключите устройство FLA от питания на 10 секунд и повторите настройку). Камин будет автоматически найден приложением. Это будет подтверждено сообщением SETUP NETWORK ACTIVE. Нажмите CONNECT.</p>		<p>Connect to Home Network</p> <p>5. На экране CONNECT TO HOME NETWORK выберите имя сети, которую вы хотите использовать (NETWORK NAME) и введите ее пароль. Убедитесь, что пароль правильный, и нажмите (SUBMIT).</p>	
---	---	--	---





Your fireplaces		Access Point	
<p>6. На экране в закладке YOUR FIREPLACES, выберите интересующее вас устройство и нажмите CONNECT. На этом экране вы также можете изменить имя камина, нажав EDIT.</p>		<p>7. Если вы не хотите использовать ни одной из доступных сетей, вы можете создать определённую сеть ACCESS POINT и подключаться к устройству напрямую. Для этого нажмите (HELP), выберите (CONNECTION TYPE), а потом (ACCESS POINT) для подтверждения нажмите (CREATE ACCESS POINT). Введите имя сети и пароль и подтвердите, нажав NEXT</p>	

После успешной настройки индикатор WiFi будет светиться зеленым цветом.



ПРИЛОЖЕНИЕ FLA3 NET-ZERO

	<ol style="list-style-type: none"> 1. Newsletter 2. Режим камина 3. Уровень топлива 4. Высота пламени. 5. Тушение и разжигание 6. Информация 7. Меню
---	---

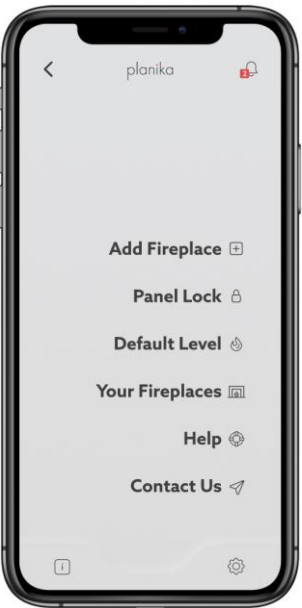
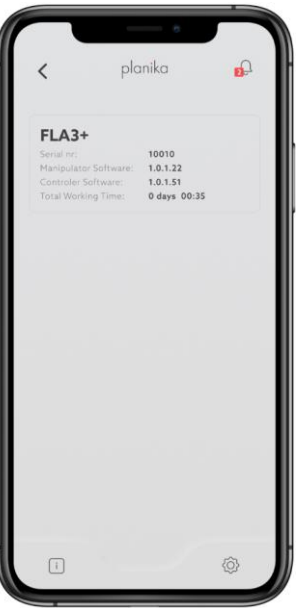
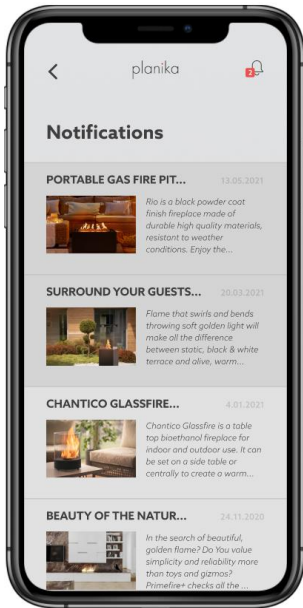

МЕНЮ

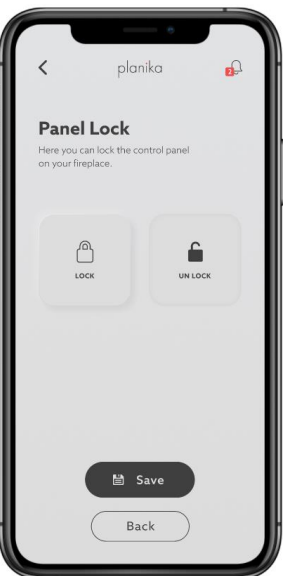
Меню доступно после нажатия на значок . Возврат на главную панель возможен с помощью нажатия значка **НАЗАД** . Для получения общей информации о камине щелкните значок . Newsletter будет доступен после нажатия на значок .

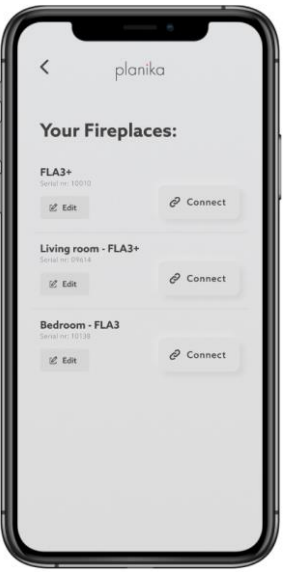
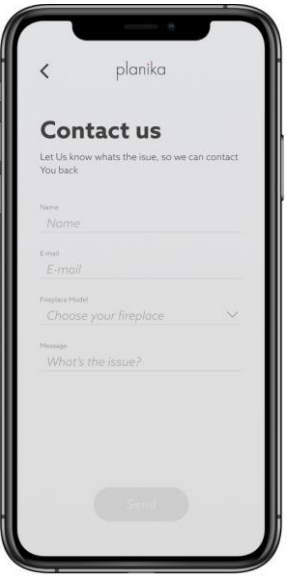
Menu	Info	Newsletter
		
<p>Основные настройки приложения. Нажмите на вкладку, чтобы изменить настройки.</p>	<p>Нажмите здесь, чтобы просмотреть основную информацию о камине.</p>	<p>Нажмите здесь, чтобы проверить уведомления.</p>

Panel Lock	Default Level	Your fireplaces	Contact Us
			
<p>Нажмите LOCK чтобы заблокировать панель управления на камине. Нажмите UNLOCK для разблокирования панели управления камином. Подтвердите свой выбор кнопкой SAVE. Изменение возможно только тогда, когда камин выключен.</p>	<p>Установите уровень пламени, при котором камин начнет работать при его включении. Нажмите SAVE чтобы сохранить изменения. RESET чтобы сбросить настройки. Заводская установка высоты пламени при включении камина на 4-ом уровне.</p>	<p>Проверьте доступные камины. Нажмите EDIT чтобы редактировать имя устройства. Нажмите CONNECT для подключения к устройству.</p>	<p>Свяжитесь с Planika по электронной почте. Нажмите SEND для отправки сообщения.</p>

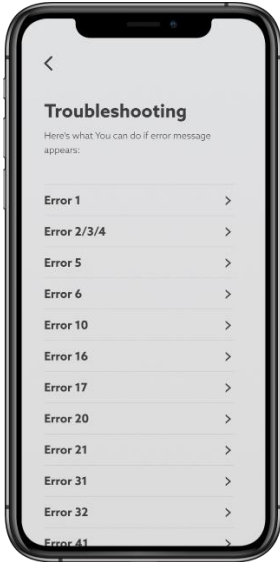
СООБЩЕНИЯ О ОШИБКАХ

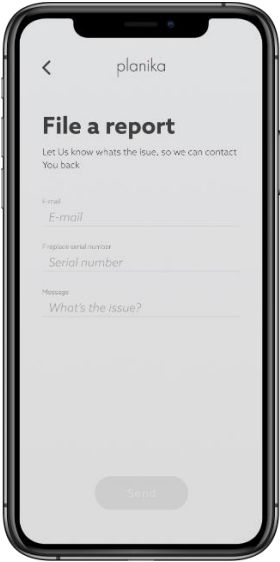
Help	Error	File a Report
		
<p>Нажмите HELP в главном меню MENU чтобы перейти к вкладке Troubleshooting.</p>	<p>Следуйте инструкции по устранению данной ошибки. Если ошибка повторится, сообщите о проблеме, нажав REPORT.</p>	<p>Если вам все еще нужна помощь службы поддержки, отправьте сообщение с описанием неисправности и основной информацией, нажав SEND.</p>

ИНФОРМАЦИОННЫЕ СИГНАЛЫ

ДИОД ПИТАНИЯ	ДИОД ЗАПУСКА/ОСТАНОВКИ	ЗВУК	ДЕЙСТВИЕ	КОММУНИКАЦИЯ
		-	Зеленый свет	Устройство выключено
		-	Зеленый свет	Устройство готово к работе
		-	Зеленый мигающий	Процедура запуска
		-		Работает
		-	Синий свет	Нет топлива - Дозаправка
		-	Синее мигание	Заправка
			Синее мигание со звуком	Полный бак
			Красный свет со звуком	Промывка, охлаждение
			Фиолетовый свет со звуком	Ошибка - проверьте приложение (устранение неисправностей) и обратитесь в сервисную службу
		-	Синее, красное мигание	Топливный бак пуст
	ДИОД WI-FI		ДЕЙСТВИЕ	КОММУНИКАЦИЯ
			Синий свет	Не подключен к wi-fi
			Синее мигание	Сопряжение / конфигурация
			Зеленый свет	Wi-fi подключен

ТОПЛИВО - -Использовать только этаноловое топливо, полученное из растений в процессе двукратной перегонки спирта, состоящее из 95-96,6% этанола по объему. Фанола является рекомендуемым топливом фармакологической чистоты. НЕ ИСПОЛЬЗУЙТЕ СИНТЕТИЧЕСКОЕ ТОПЛИВО НА НЕФТЯНОЙ ОСНОВЕ, ТАК КАК ОНО ЗАГРЯЗНЕНО, ИЗДАЕТ НЕПРИЯТНЫЙ ЗАПАХ И МОЖЕТ ПОВРЕДИТЬ КАМИН! НЕ ИСПОЛЬЗУЙТЕ ТОПЛИВО, СОДЕРЖАЩЕЕ 100% ЭТАНОЛА ПО ОБЪЕМУ, ГЕЛЬ ИЛИ АРОМАТИЧЕСКОЕ ТОПЛИВО!

ЧИСТКА – Для чистки использовать мягкий материал и нежные чистящие средства, когда устройство не работает и охлаждено.

СЕРВИСНОЕ ОБСЛУЖИВАНИЕ – Сохраните прилагаемый USB-кабель для обслуживания. Адрес электронной почты для контакта со службой поддержки service@planikafires.com